

A large, dynamic splash of clear water with iridescent rainbow colors, set against a light blue background. The water flows from the left and curves across the middle of the page.

MEDIAL

KEEP IT CLEAN | KEEP ON CARING



THE MEDIAL WORLD, ALL IN AN APP.

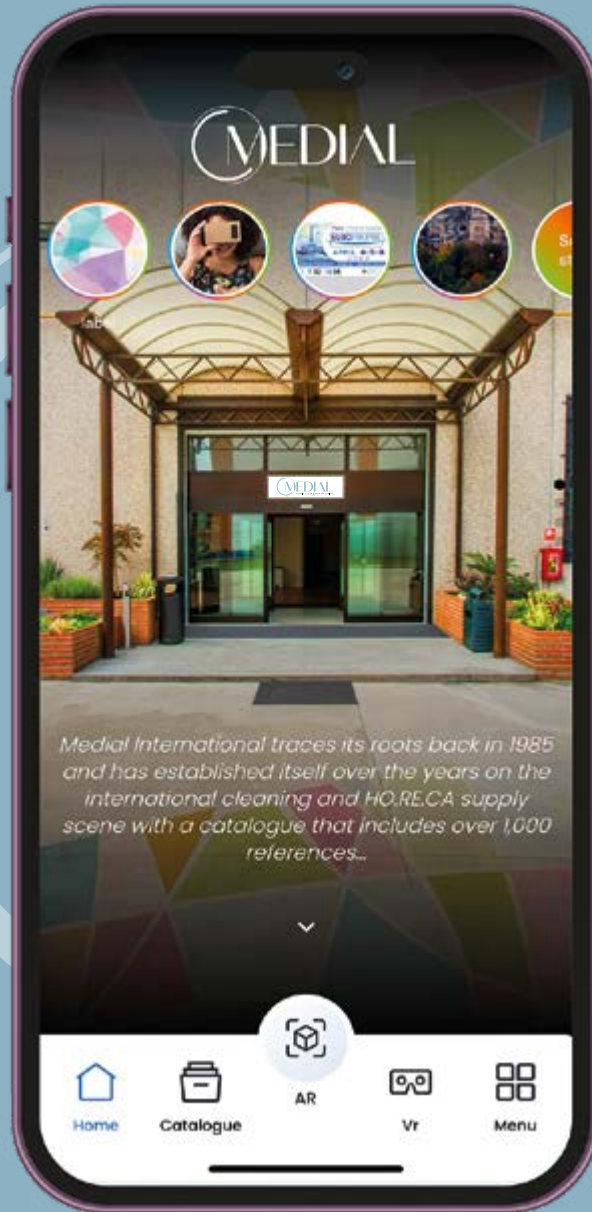

GOOGLE PLAY



APP STORE



Scan the QR code with your smartphone and download our Medial App now.

WE ARE MEDIAL



OUR MISSION

With our products, we aim to **care for workspaces, for people, for the Planet.**

'**Keep it Clean, Keep on Caring**', for us, is not just a promise, but a credo that we apply to our living and working every day.

OUR VISION

For us, **making clean means making better.**

That is why we want to continue to strive, through our activities, to **provide professional quality solutions for the hygiene, conservation and decoration of public spaces on a global scale**, reducing our impact on the environment to contribute to a cleaner Planet.

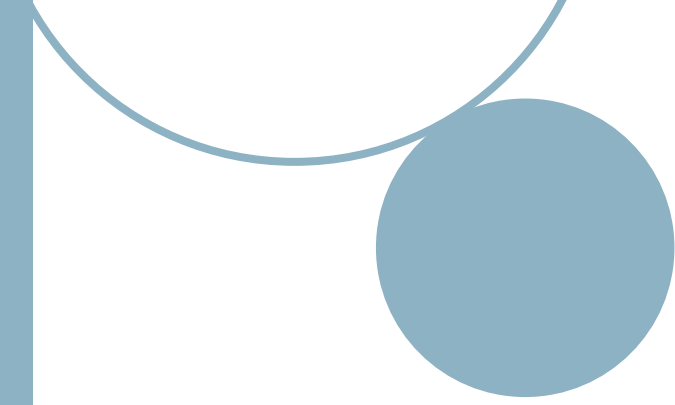

Dear reader,

*we are delighted to find you again or to find you for the first time. We have decided to innovate our **2025 Catalogue** in honour of the **company's 40th anniversary**. Our aim is to reach out to you and make it easier for you to read our catalogue. This is the reason why **our product universes, have become three:***

WASTE MANAGEMENT, HYGIENE and FURNISHING ACCESSORIES.

*Within the large **Waste Management** umbrella, we wanted to simplify the search to identify **SPACES** first and foremost, whether they are **INDOORS** or **OUTDOORS**. In a second plan, our product portfolio have been defined according to destination and type of use, whether it be **HORECA, CLEANING, WASTE SORTING** or **COMMON AREAS**.*

*The **Hygiene** universe has also undergone renovation, in fact the subdivision into **DISPENSERS AND HOTEL ACCESSORIES, HAND & HAIR DRYERS, PERSONAL CARE** and **ENVIRONMENTAL CARE** can guide the product search based on actual needs.*

*The last and new category **Furnishing Accessories** represents our area of growth, in fact it will be replenished over the years with the aim of having a catalogue more and more specialised in the generalist field.*





























We have also introduced a digital index using QR codes to make it easier to find products!

Enjoy exploring,



Medial

LEGEND

This year more than ever, it is important to use icons to better understand the characteristics of our products. The icons will in fact complement the product descriptions in text form. Here follows the legend, an essential key to having all the information at your fingertips.

			
 New product	 Bag for waste bin	 Screws included	 Automatic operation with Infrared sensor
 Good quality - price ratio	 Container's capacity	 Screws not included	 Self-extinguishing
 Key lock system with key	 Liquid soap	 Battery power supply x Number of batteries (Included)	 Suitable for use in covered outdoor areas
 Vandal proof	 Foam soap	 Battery power supply x Number of batteries (Not Included)	 Ideal for naval supplies
 Window for level check	 Spray soap	 Power supply (Included)	 Warranty Period
 Product to encourage waste separation	 Towels Paper folding	 Power supply (Not Included)	 Integrated ozone generator
 Anti Finger-Print treatment	 Diameter paper roll	 USB power supply (USB cable included)	 Possibility to customize product configuration
 Waterproof design	 Interfolded paper	 USB power supply (USB cable not included)	 Flying insect killer
 Scent		 Wi-Fi System	

Certifications and compliance

 In compliance with CE regulation	 TUV UNI EN 840 certified
 In compliance with HACCP plan	 TUV DIN EN ISO 9001 certified
 In compliance with ROHS regulation	 GS certified Security test
 CNPP certified	 Level of Acoustics Power

Sustainability

 Recycled Plastic	 Plastic Second Life
 Biodegradable material	 100% Regenerated Nylon
 GOTS certified	

OUR VALUES

WE TAKE CARE OF OUR PRODUCTS, AND OUR CUSTOMERS

Over a thousand products in the catalogue, **guaranteed by 40 years of experience** and a leading company in the cleaning and metalworking sector. We offer not only a careful selection of products, but also a careful listening to customers' needs and a customised service that makes us unique.

WE CARE FOR THE PLANET, AND THE PEOPLE WHO LIVE ON IT

Sustainability is important to us: we have chosen photovoltaic systems with the aim of producing clean energy and reducing greenhouse gas emissions. In addition, we are always looking for innovative green oriented solutions, and we give as well space to PSV (Plastic Second Life) products. Because we only have one planet, and we want to respect it.

KEEP IT CLEAN, KEEP ON CARING.



OUR HISTORY



CLEANING SPECIALISTS SINCE 1985

We were founded 40 years ago with the aim of **offering the best selections for professional hygiene and cleaning**. Over time we have expanded our offer, without ever losing our focus on quality and with the aim of **satisfying increasingly complex needs**.

In forty years we have grown, combining a **Made in Italy** touch and taste with a Global vision that has allowed us to expand in Europe and beyond. And today, we continue to bring Medial quality to the World.

OUR EXPERTISE IN METAL PRODUCTS, FOR THE HIGHEST QUALITY

In 2008 we acquired **Metalnova**, which allowed us to specialise in the production of **metal** containers and dustbins. More than 15 years of experience in this type of work have created the foundations for the conception of a unique know-how with an offer of **high quality metal** products alongside other plastic references, for an all-round proposal always oriented towards **product durability and functionality**.

OUR STRENGTH



Our strength is **quality**:
from design to sale, we offer
the utmost attention to the
product and the customer.

STUDIO & DESIGN

Experience and innovation come together to create
a product offering that combines design and
functionality.

QUALITY/CERTIFIED PRODUCTION

Two production sites for maximum optimisation
of internal processes and products guaranteed by
ISO 9001 certification.

LOGISTICS

Over 10,000 m² of warehouse space with more than
350,000 items in stock, with a carefully planned
flow of goods to ensure timely deliveries. Thanks to
the new Warehouse Management System (WMS)
we can guarantee even more picking accuracy,
reducing lead times and maximising productivity.

SALES NETWORK

An extensive network in Italy and Europe, always
ready to listen and satisfy our customers' needs.

OUR TECHNIQUE

We give shape to your ideas: with our **customisation services** with the most **innovative** techniques.

● PAD PRINTING

Perfect for customising irregular or spherical surfaces with optimal results at low prices.

● SCREEN PRINTING

For optimum colour rendering even on non-absorbent materials or surfaces that are not perfectly smooth.

● DIGITAL TRANSFER

Digital printing for excellent results even in four-colour process with sharp and brilliant colour rendition.

● LASER CUSTOMIZATION

3D laser engravings for the optimal reproduction of graphic elements, thanks to the in-house presence of the machinery, which allows maximum control of the output, resulting in an accurate and quality result.



SUSTAINABILITY: OUR PRESENT, OUR FUTURE.

TOWARDS TOMORROW WITH A NEW ENERGY

We believe in sustainability, and take concrete actions every day to help **reduce our impact on the environment**. This is why we have chosen to invest in **photovoltaics**, and make our factory greener by **producing clean energy and reducing greenhouse gas emissions**.

Today, in the Medial factory, we have photovoltaic panels with a maximum power of 140KW, which contribute to making us - in our small way - an **integral part of the transition process towards renewables**.

And this is just a first step in a path that we intend to continue along in the coming years with **actions aimed at reducing our impact on the environment**.

WE REUSE
ENERGY

WE SAVE **Co²**



RECYCLING IS CREATING.

A SECOND LIFE TO PLASTICS

The Institute for the Promotion of Plastics Recycling (IPPR) has established the **PSV Plastics Second Life certification**, an environmental certification that enhances the value of products resulting from the recycling of household and post-industrial plastic waste, thus emphasising **the quality and traceability of recycled materials**. They can be found in the catalogue thanks to the 'Plastic Second Life' logo.



A CHOICE OF QUALITY

Quality is always our goal. And we do not only mean the quality of products, but also of life. This is why, we have included in our waste bin product portfolio the **recycled plastic ranges ECOCONTI, STILECO, ECO RIF and BASKET**, in which quality and functional aesthetics are combined with a sustainable vision of the future. For the furnishing accessories, our entrance mat range such as **AQUA, DELTA** and **DURATAP** are made with **ECONYL, 100% regenerated nylon**.



OUR PARTNERS



Our Partnership with 3M, which began in 2016, continues to grow in the area of **professional cleaning, maintenance and safety**, with a new specific focus on the development of complementary and related sectors to Cleaning such as hardware, marinas and more generally the whole world of industry as well as large-scale distribution.

Currently, the 3M range distributed by Medial includes: non-slip products, microfibre cloths, sponge laminates, green fibre.



From 2021, our chemical division. A chemical company founded in 1999, specialising in the production of professional detergents and perfumers for industrial environments, HO.RE.CA., sanitary cleaning, the food industry, mobile toilets, the nautical industry and means of transport.

TRADE FAIRS AND EXHIBITIONS

International trade fairs are an opportunity to showcase our expertise and capabilities. For this reason, Medial actively participates in the most relevant industry events.

Among the unmissable appointments: **INTERCLEAN in Amsterdam**, a global reference point for the cleaning and hygiene sector, and **PULIRE in Rho Fieramilano**, the event dedicated to professional cleaning and sanitation, supported by **ISSA and Afidamp**.

We look forward to seeing you again this year at the 27th edition of PULIRE to celebrate our 40th anniversary in **Hall 12, Stand F27 G20!**

BECAUSE **40 YEARS** ARE NOT TO BE CELEBRATED, THEY NEED TO BE BUILT. **STEP BY STEP**, TOGETHER.







GENERAL INDEX

SCAN THE
QR CODE
TO ACCESS
DIGITAL INDEX



WASTE MANAGEMENT

INDOOR AREAS

HO.RE.CA	P. 20
CLEANING	P. 34
WASTE SORTING	P. 46
COMMON AREAS	P. 76

OUTDOOR AREAS

WASTE SORTING	P. 94
COMMON AREAS	P. 110

HYGIENE

DISPENSERS AND HOTEL ACCESSORIES	P. 126
HAND & HAIR DRYERS	P. 170
PERSONAL CARE	P. 198
ENVIRONMENTAL CARE	P. 212

FURNISHING ACCESSORIES

P. 238

WASTE MANAGEMENT

WASTE MANAGEMENT IS A PROCESS CONSISTING OF THE ACTIVITIES OF COLLECTION, TRANSPORT, TREATMENT AND DISPOSAL, AS WELL AS THE RECOVERY OR RECYCLING OF MATERIALS SUCH AS PAPER, PLASTIC, WOOD, GLASS, METAL.

The fundamental principle behind waste management is the **protection of health** and this concept is represented in MEDIAL's mission as **the care and preservation of both indoors and outdoors public spaces.**

The choice of waste collection instrument therefore becomes crucial due to the different uses and destinations that are represented for Medial as Horeca, Cleaning, Waste sorting and Common areas. For each environment, in fact, there are standards to be met at the level of the material identified, certification or regulations to be expected, product capacity or facilitation for the purpose of use.

The solutions that Medial can offer advocate the promotion of the circular economy through the use of recycled materials for dedicated ecological lines, and the management of any dangers that may arise through the choice of non-fire-propagating waste containers and many other proposals designed to improve the well-being of people's lives. Waste management is an activity that requires careful planning and compliance with strict **regulations** to ensure the **protection of human health and the environment.**

For this reason Medial wants to accompany people in a path of quality and support towards civilised and responsible practices that tend to contribute to the protection of the Planet.



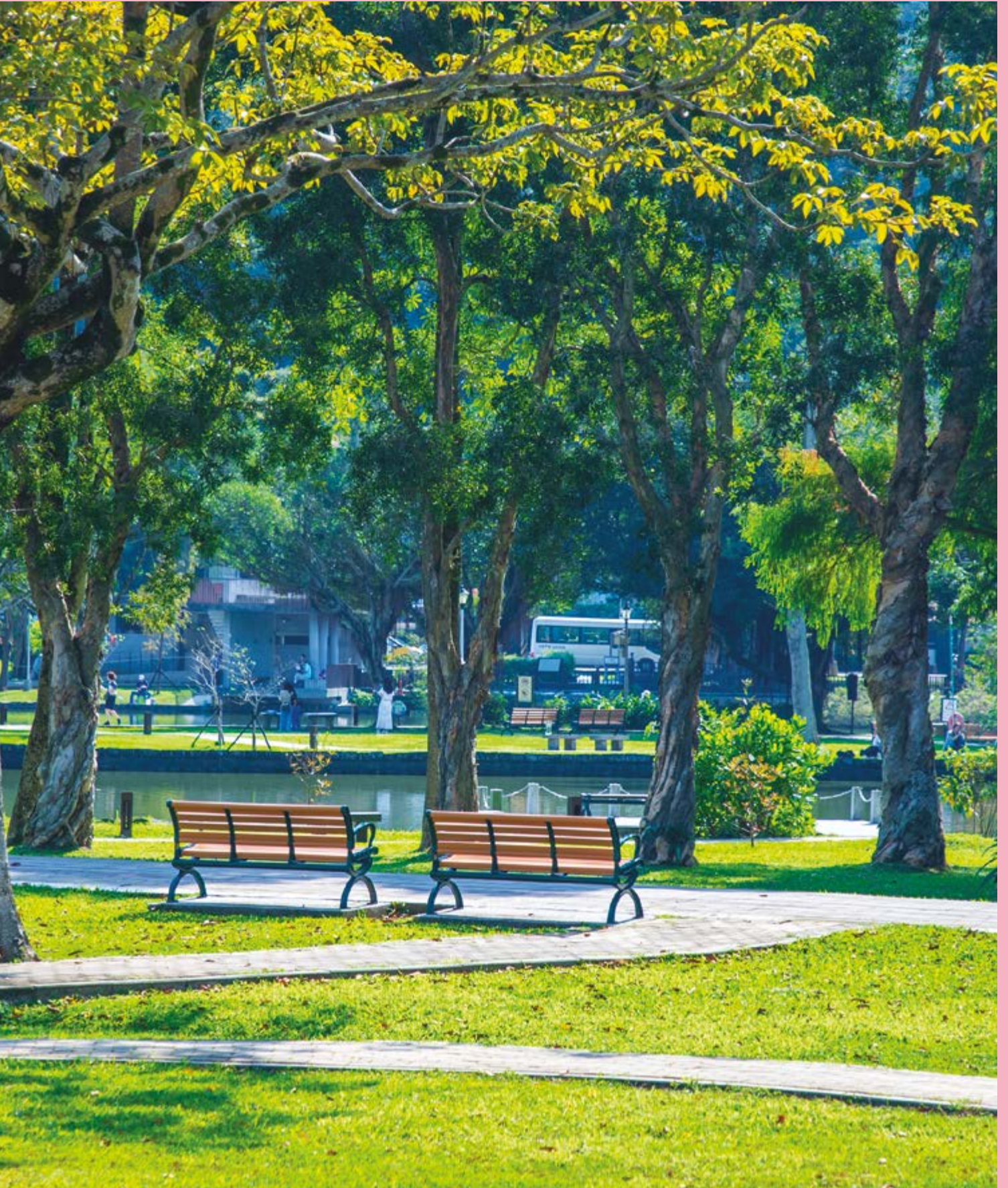



WASTE MANAGEMENT

INDOOR AREAS

HO.RE.CA	P. 20
<i>METALS</i>	P. 22
<i>PLASTIC AND OTHER MATERIALS</i>	P. 31
CLEANING	P. 34
<i>METALS</i>	P. 36
<i>PLASTIC AND OTHER MATERIALS</i>	P. 41
WASTE SORTING	P. 46
<i>METALS</i>	P. 48
<i>PLASTIC AND OTHER MATERIALS</i>	P. 69
COMMON AREAS	P. 76
<i>METALS</i>	P. 78
<i>PLASTIC AND OTHER MATERIALS</i>	P. 88

OUTDOOR AREAS

WASTE SORTING	P. 94
<i>METALS</i>	P. 97
<i>PLASTIC AND OTHER MATERIALS</i>	P. 105
COMMON AREAS	P. 110
<i>METALS</i>	P. 112
<i>PLASTIC AND OTHER MATERIALS</i>	P. 121

WASTE MANAGEMENT

INDOOR AREAS

Medial hopes to be able to qualify with an increasingly broader offer that responds, in terms of versatility and extension, to the needs of its customers. For this reason, the chapter on WASTE MANAGEMENT has been rationalized firstly including both products for **INDOOR AREAS** and equipment for OUTDOOR AREAS.

The second classification is based on the **intended use** of the product. This gave rise to the subcategories HORECA, CLEANING, WASTE SORTING and COMMON AREAS.

HORECA refers to the hotel industry sector for which products whose main use is in the Catering and Hotellerie sector are favored.

The **CLEANING** section is dedicated to references for cleaning and professional hygiene (mainly services - bathrooms - public and professional).

The segment relating to **WASTE SORTING** brings together products conceived with the aim of encouraging a waste sorting system that facilitates recycling and the reduction of pollution.

The **COMMON AREAS** segment brings together a category of more generic products designed to facilitate waste management in public spaces (offices, hotels, etc.).





WASTE MANAGEMENT

INDOOR AREAS

HO.RE.CA.





MEC

WASTE CONTAINER WITH SWINGING DOOR



120 L ▶



1305 mm
565 mm
600 mm

- Brushed stainless steel body with swing door for easy access to the bin
- Front door with triangular key lock
- Top tray holder sold separately (LxPxH 605x460x115 mm)
- Adjustable feet (5 cm max height)
- Holds a 120 L watertight wheeled waste bin (not included)
- Ideal for food service facilities
- Related items: 120 L waste container (page 106)
- Four wheels Ø 40 mm as option (2 with breaks)



Swing door
540x220 mm



120 L container
sold separately



Wheels optional

Brushed s.steel bin 120 L **789000**

Brushed s.steel tray stand **789010**

Four wheels kit Ø 40 mm (2 w/breaks) **789099**

MINI MEC

WASTE CONTAINER WITH SWINGING DOOR



50 L ▶



1160 mm
324 mm
400 mm

1075 mm
324 mm
400 mm

- Brushed stainless steel or coated steel body
- Swinging door for easy access to the bin
- Top tray holder sold separately (LxPxH 405x268x115 mm)
- Inside bag holder from galvanized steel
- Front door with triangular key lock
- Adjustable feet (5 cm max. height)
- Four wheels Ø 40 mm as option (2 with breaks)



Swing door
340x217 mm



Sack holder included



Wheels optional

Brushed s.steel waste container 50 L **789005**

White steel waste container 50 L **789006**

Brushed s.steel tray stand **789011**

White coated steel tray stand **789012**

Four wheels kit Ø 40 mm (2 w/breaks) **789099**

SBARAZZINO

MOBILE WASTE CONTAINER WITH PEDAL AND CENTRAL OPENING



70 L ▶



725 mm
520 mm
550 mm

∅ 95 mm

- Polished stainless steel body and lid
- Push bar and pedal from powder epoxy coated steel
- Removable front panel for easy bag change
- Elastic strap for holding the bag in place
- Two smooth wheels for easy maneuvering
- To be placed under worktops or table waste hatches
- Patented product



Under central opening, height 770 mm



Opening



Under the workshop

Central opening waste container polished s.steel 70 L

790680

FRONTINOX

MOBILE PEDAL WASTE CONTAINER WITH FRONT OPENING



70 L ▶



755 mm
450 mm
480 mm

∅ 95 mm

- Polished stainless steel
- Push bar and pedal in powder epoxy coated steel
- Front opening for easy bag change
- Elastic strap for holding the bag in place
- Two smooth wheels for easy maneuvering



Opening

Front opening waste container polished s.steel 70 L

790640

CONTINOX

MOBILE PEDAL WASTE CONTAINER



110 L ▶



965 mm
440 mm
480 mm

ø 95 mm

70 L ▶



755 mm
440 mm
480 mm

ø 95 mm



Wide opening



Removable front door

- Stainless steel body and lid, with polished or brushed finish
- Push bar and pedal in coated steel or s.steel
- Removable front panel for easy bag change
- Elastic strap for holding the bag in place
- Two smooth wheels for easy maneuvering



Pedal container polished s.steel 70 L	790630
Pedal container brushed s.steel 70 L	790650
Pedal container polished s.steel + s.steel tubes 70 L	790670
Pedal container polished s.steel 110 L	790624
Pedal container brushed s.steel 110 L	790644
Pedal container polished s.steel + s.steel tubes 110 L	790664



CONTIMAR

SELF EXTINGUISHING MOBILE PEDAL WASTE CONTAINER



70 L ▶

110 L



Free of openings

- Stainless steel body and lid, with polished finish
- Push bar and pedal in s.steel
- Elastic strap for holding the bag in place
- Smooth wheels for easy maneuvering
- Inner structure free from openings to prevent fire from spreading
- **Ideal for naval use**
- **Attested by Rina Services SPA, a naval certification body, for waste collection aboard ship**
- **CNPP certified as fireproof and fire retardant**



755 mm
440 mm
480 mm

ø 95 mm

Pedal container polished s.steel 70 L

790660

CONTICOLOR

MOBILE PEDAL WASTE CONTAINER



110 L ▶

110 L



70 L 110 L

- Powder epoxy coated steel body and lid
- Several color options available to encourage waste separation (Vers. 110 L)
- Removable front panel for easy bag change
- Elastic strap for holding the bag in place
- Two smooth wheels for easy maneuvering



965 mm
440 mm
480 mm

755 mm
440 mm
480 mm

ø 95 mm

Colors available 110 L version:



Pedal container white steel 70 L **791130**

Pedal container white steel 110 L **791124**

Pedal container blue steel 110 L **791225**

Pedal container yellow steel 110 L **791226**

Pedal container red steel 110 L **791227**

Pedal container green steel 110 L **791228**

Pedal container black steel + s.steel tubes 110 L **791221**



Wide opening



Removable front door

CONTIFIX

STATIC PEDAL WASTE CONTAINER



110 L ▶



965 mm
440 mm
480 mm



Wide opening



Removable front door

- Polished stainless steel body and lid
- Push bar and pedal in coated steel
- Removable front panel for easy bag change
- Elastic strap for holding the bag in place
- Static base to prevent accidental moving



Static pedal container polished s.steel 110 L

790724

CONTIFIX COLOR

STATIC PEDAL WASTE CONTAINER



110 L ▶



965 mm
440 mm
480 mm



Wide opening



Removable front door

- White coated steel body and lid
- Removable front panel for easy bag change
- Elastic strap for holding the bag in place
- Static base to prevent accidental moving



Static pedal container white steel 110 L

791224

CONTIMAR FIX

SELF EXTINGUISHING STATIC PEDAL WASTE CONTAINER



70 L ▶



760 mm
440 mm
480 mm



Free of openings

- Stainless steel body and lid, with polished finish
- Push bar and pedal in stainless steel
- Elastic strap for holding the bag in place
- Tubular stainless steel supports with four support points
- Inner structure free from openings to prevent fire from spreading
- **Ideal for naval use**
- **Attested by Rina Services SPA, a naval certification body, for waste collection aboard ship**
- **CNPP certified as fireproof and fire retardant**



Static pedal container polished s.steel 70 L

790760

QUARANTA

PEDAL WASTE CONTAINER

40 L ▶



625 mm
360 mm

- Polished stainless steel body and lid
- Built-in back handle for easy moving
- Silent closing lid
- Plastic inner bucket with handle
- Metal pedal with rubber lining
- Non-scratch plastic base



Pedal waste container polished s.steel 40 L

101400

STAGNO

WATERTIGHT PEDAL WASTE CONTAINER



90 L ▶



900 mm
400 mm

70 L ▶



700 mm
400 mm

- AISI 304 stainless steel body and lid, with scotch brite finishing
- AISI 304 stainless steel pedal
- Watertight waste container
- Easy-grip side handles
- Removable lid and container for easy cleaning and maintenance
- Rotating non-marking rubber wheels



Watertight cont. brushed 304 s.steel 70 L

792070

Watertight cont. brushed 304 s.steel 90 L

792090

PELICANTE

PEDAL WASTE CONTAINER



80 L ▶



765 mm
420 mm

60 L ▶



610 mm
420 mm

- Stainless steel body and lid
- Galvanized inner bucket with metal handle
- Metal pedal with rubber lining
- Non-scratch rubberized base



Pedal bin polished s.steel 80 L

790280

Pedal bin polished s.steel 60 L

790260

CONTIMOBILE

MOBILE BAG HOLDER WITH LID



110 L ▶



Colors available:



Wide opening



Board
260x10x320 mm



Info board with
sticker

- Available from polished s.steel (AISI 430 or 304) or epoxy coated steel
- Colored lids to encourage waste separation
- Elastic strap for holding the bag in place
- Non-marking plastic wheels Ø 150 mm
- Self assembly required
- Information board optional



Pedal bag holder 430 polished s.steel 110 L	601041
Pedal bag holder 304 polished s.steel 110 L	601046
Pedal bag holder white steel 110 L	601042
Pedal bag holder grey steel 110 L	601043
Pedal bag holder white-yellow steel 110 L	601044
Pedal bag holder white-blue 110 L	601045
Pedal bag holder white-red steel 110 L	601047
Pedal bag holder white-green steel 110 L	601048
Information board grey manganese steel	601035



CONTICLAP

BAG HOLDER WITH SEALING CLIP

110 L ▶



Opening



Hook



2 Wheels with brake

960 mm
430 mm
600 mm

- Tubular polished stainless steel frame
- Rubber bands for holding the bag sealed
- For 110 litres liners
- Large pedal for hands-free operation
- Two wheels with brakes



Bag holder with sealing clip polished s.steel 110 L

107500



CONTITOP MOBILE

MOBILE PEDAL CONTAINER

90 L ▶
110 L

830 mm
410 mm
500 mm



∅ 125 mm

70 L ▶
110 L

670 mm
400 mm
500 mm



Colors available:



Wheels ∅ 125 mm



Opening mechanism

- Polypropylene
- Plastic opening mechanism
- Four lid colors to encourage waste separation
- Integrated plastic wheels
- Sold in 1 pc/box or 3 pcs/box (both to be assembled)



	1 PCS		3 PCS	
	70 L	90 L	70 L	90 L
Mobile pedal waste container white	115570	115590	115070	115090
Mobile pedal waste container white-blue	115575	115595	115075	115095
Mobile pedal waste container white-yellow	115576	115596	115076	115096
Mobile pedal waste container white-red	115577	115597	115077	115097
Mobile pedal waste container white-green	115578	115598	115078	115098

CONTITOP

PEDAL CONTAINER

- Polypropylene
- Plastic lid opening system
- Four lid colors to encourage waste separation
- Sold in 1 pc/box or 3 pcs/box (both to be assembled)



Colors available:



	1 PCS				3 PCS			
	30 L	45 L	70 L	90 L	30 L	45 L	70 L	90 L
Pedal container white	115350	115450	115750	115950	115300	101450	115700	115900
Pedal container white-blue	115355	115455	115755	115955	115305	101455	115705	115905
Pedal container white-yellow	115356	115456	115756	115956	115306	101456	115706	115906
Pedal container white-red	115357	115457	115757	115957	115307	101457	115707	115907
Pedal container white-green	115358	115458	115758	115958	115308	101458	115708	115908

CONTIPLAST

MOBILE PEDAL CONTAINER



- Polypropylène (PP5)
- Aluminum opening mechanism
- Four lid colors to encourage waste separation
- Sold in 1 pc/box (assembled) or 3 pcs/box (unassembled)



Colors available:



	1 PCS	3 PCS
Pedal waste container grey 120 L	102530	102030
Pedal waste container white 120 L	102534	102034
Pedal waste container white - blue 120 L	102535	102035
Pedal waste container white - yellow 120 L	102536	102036
Pedal waste container white - red 120 L	102537	102037
Pedal waste container white - green 120 L	102538	102038

CONTI

MOBILE PEDAL CONTAINER

80 L ▶



750 mm
390 mm
480 mm



Wheels Ø 70 mm



Pedal

- Polypropylene
- Plastic lid opening mechanism
- Lids and plastic pedal colors available for waste separation
- Integrated plastic wheels and large foot pedal
- Sold in 1 pc/box or 3 pcs/box (both to be assembled)



Colors available:



80 L

1 PCS 3 PCS

Waste container white	912850	912800
Waste container grey - white	912852	912802
Waste container white - blue	912855	912805
Waste container white - yellow	912856	912806
Waste container white - red	912857	912807
Waste container white - green	912858	912808
Waste container white - brown	912859	912809

ECO CONTI

MOBILE RECYCLED PLASTIC (MIN. 70%) PEDAL CONTAINER

80 L ▶



60 L ▼



750 mm
390 mm
480 mm

550 mm
390 mm
480 mm



Wheels Ø 70 mm



Pedal

- **Recycled plastic (min.70%)**
- Plastic lid opening mechanism
- Lids and plastic pedal colors available for waste separation
- Integrated plastic wheels and large foot pedal
- Sold in 1 pc/box or 3 pcs/box (both to be assembled)



Colors available:



80 L

60 L

1 PCS 3 PCS 1 PCS 3 PCS

Waste container grey - white	912870	912820	912670	912620
Waste container grey	912872	912822	912672	912622
Waste container grey - blue	912875	912825	912675	912625
Waste container grey - yellow	912876	912826	912676	912626
Waste container grey - red	912877	912827	912677	912627
Waste container grey - green	912878	912828	912678	912628
Waste container grey - brown	912879	912829	912679	912629

WARNING: some recycled plastic products may have slight variations in colour shade

WASTE MANAGEMENT

INDOOR AREAS

CLEANING





BRINOX

SANITARY TOWEL DISPOSAL BIN



30 L ▶



400 mm
405 mm
193 mm

- AISI 304 brushed stainless steel
- Front opening with pedal
- Ideal to collect sanitary towels
- Lid includes a soft-close system
- Stainless steel keyed lock
- Holds antimicrobial bags (code 130202)



Opening



Pedal

Sanitary towel disposal bin AISI 304 brushed s.steel 30 L **789080**

BRINOX

PUSH OPENING WASTE BIN

25 L ▶



640 mm
163 mm
355 mm

- AISI 304 polished s.steel or AISI 201 brushed s.steel
- Push door access to bin
- Inner sack holder
- Wall mounted fastening or freestanding



Push opening waste bin AISI 304 polished s.steel 25 L **110520**

Push opening waste bin AISI 201 brushed s.steel 25 L **110521**

COMPLETE THE RANGE WITH:

STORICO

SWING WASTE BIN

50 L ▶ Ref. 790563

Page 81

50 L ▶



STORICO

PUSH WASTE BIN

50 L ▶ Ref. 790557

Page 80

50 L ▶



BOB

WASTE BIN



25 L ▶



Inner bucket
(25 L)



- Stainless steel, with polished or brushed finish
- Galvanized inner bucket with handle
- Freestanding or wall mounted fastening



Waste bin Polished s.steel 25 L

773001

Waste bin Brushed s.steel 25 L

773006

BOB BASIC

WASTE BIN



30 L ▶



- Stainless steel, with polished or brushed finish
- Freestanding or wall mounted fastening



Waste bin Polished s.steel 25 L

773002

Waste bin Brushed s.steel 25 L

773007

BRINOX

WALL-MOUNTED WASTE BIN

10 L ▶

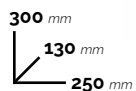

- AISI 304 stainless steel, with polished or brush finish
- Inner bag holder



Wall-mounted waste bin AISI 304 polished s.steel 10 L **105062**

Wall-mounted waste bin AISI 304 brushed s.steel 10 L **105063**

PURA

WALL-MOUNTED WASTE BIN

10 L ▶

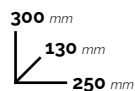

- White powder epoxy coated steel
- Inner bag holder



Wall mounted waste bin white steel 10 L

105061

MILUNA

WALL MOUNTED WASTE BIN



- Stainless steel with brushed finish
- Powder epoxy coated steel
- Bag held in place by elastic band
- Wall mounted fastening



40 L ▶



647 mm
195 mm
395 mm

20 L ▶



388 mm
195 mm
395 mm

Colors available:



AVAILABLE IN AR ON MEDIAL APP

	BLACK	WHITE	BRUSHED S.STEEL
Wall mounted waste bin 20 L	773031	773033	773036
Wall mounted waste bin 40 L	773041	773043	773046



BIN 304

PEDAL BIN

- AISI 304 polished stainless steel
- Built in plastic handle
- Plastic inner bucket
- Metal pedal with plastic lining
- Non-scratch plastic base



Handle

5 L ▶



290 mm
180 mm



14 L ▶



380 mm
270 mm



20 L ▶



440 mm
270 mm



5 L	14 L	20 L
906705	906712	906720

Pedal bin polished AISI 304 s.steel

BIN PLUS

PEDAL BIN

- Stainless steel or coated steel
- Back handle for easy moving
- **Silent closing lid**
- Lid may be blocked to facilitate bag replacement
- Plastic inner bucket, pedal and base



3 L ▼



250 mm
170 mm



5 L ▼



278 mm
205 mm



12 L ▼



385 mm
250 mm



20 L ▼



450 mm
290 mm



30 L ▼



650 mm
290 mm



	3 L	5 L	12 L	20 L	30 L
Pedal bin white steel	112036	112056	112126	112206	112306
Pedal bin polished stainless steel	112035	112055	112125	112205	112305
Pedal bin brushed stainless steel	112039	112059			

BIN GALVA

PEDAL BIN WITH GALVANIZED STEEL INNER BUCKET

5 L ▶



278 mm
205 mm

12 L ▶



400 mm
250 mm



Inner bucket

- Polished stainless steel body
- Galvanized steel inner bucket
- Metal carry handle on the back
- Metal pedal with plastic lining
- Non-scratch plastic base



5 L	12 L
-----	------

Polished s.steel bin with galvanized bucket

106405

106412

NEW BIN BASIC

PEDAL BIN

- Polished stainless steel and white or black coated steel
- Plastic back handle
- Plastic inner bucket
- Metal pedal with plastic lining (vers. s. steel)
- Plastic pedal (vers. white and black coated steel)
- Non-scratch plastic base



3 L ▼



235 mm
185 mm

5 L ▼



265 mm
223 mm

12 L ▼



370 mm
260 mm

20 L ▼



445 mm
305 mm



30 L ▼



625 mm
305 mm



Colors available:



Foldable handle

	3 L	5 L	12 L	20 L	30 L
Pedal bin polished s.steel	913030	913050	913120	913200	913300
Pedal bin white coated s.steel	913031	913051	913121		
Pedal bin black coated s.steel		913052			

NOIR

SANITARY TOWEL DISPOSAL BIN

15 L ▶



Opening

480 mm
428 mm
174 mm

- Body and lid made of black ABS
- Front opening with pedal
- Lid can be used as bag holder
- Optional - holds antimicrobial bags (code 130202)



Black ABS sanitary bin 15 L

104281

BASICA

SANITARY TOWEL DISPOSAL BIN

15 L ▶



Colors available:



480 mm
428 mm
174 mm

- Body and lid from ABS, white or grey
- Front opening with pedal
- Lid can be used as bag holder
- Optional antimicrobial scented liners (cod. 130202)



Grey sanitary towel disposal bins 15 L

104080

White sanitary towel disposal bins 15 L

104081

LADY BIN

SANITARY TOWEL DISPOSAL BIN

17 L ▶



- Body and lid from polypropylene
- Special front opening with pedal
- Lid can be used as bag holder
- Optional antimicrobial scented liners (cod. 130202)



495 mm
440 mm
235 mm

White-red sanitary towel disposal bins 17 L

705081

AMÉLIE

AUTOMATIC MURAL TRASH CAN

12 L ▶

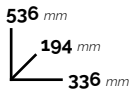

Colors available:



Integrated Ozone Generator



Sack holder and Wall-mounting kit



Wall mounted



- PP / ABS body and lid (black or white)
- Smart sensor: contactless, more hygienic
- Infrared and vibration opening sensors
- Integrated ozone generator (99.9% effectiveness)
- Battery operated: 2 x "AA" batteries (not included)
- Sack holder included
- IPX4 class protection
- Freestanding or wall-mounted (kit included)



BLACK automatic mural trash can - 12 L

111211

WHITE automatic mural trash can - 12 L

111213

AMÉLIE

MURAL TRASH CAN

32 L ▶

60x
80cm



570 mm
280 mm
414 mm

12 L ▶

50x
60cm



518 mm
195 mm
328 mm

Colors available:



Sack holder and Wall-mounting kit



Wall mounted



Opening



- PP body and lid (black or white)
- Special lid shape keeps the wastes out of sight
- Sack holder included
- Freestanding or wall-mounted (kit included)



BLACK Mural trash can - 12 L

111201

WHITE Mural trash can - 12 L

111203

BLACK Mural trash can - 32 L

111221

WHITE Mural trash can - 32 L

111223

RIF BASIC

SWING WASTE BIN

- High-density polypropylene plastic
- Swing access to bin-lid can be used as sack holder
- Wall mounting kit sold separately
- Sold in multi-pack
- **35 L version available in single packaging (Ref. 909536*)**



Wall bracket
35 / 50 L



Wall bracket
10 / 18 L

10 L ▶



360 mm
190 mm
240 mm

18 L ▶



460 mm
235 mm
290 mm

35 L ▶



560 mm
290 mm
360 mm

Available in packaging
single (Ref. 909536*)

Colors
available
35 L:



50 L ▶



680 mm
330 mm
420 mm

	10 L (24 pz)	18 L (12 pz)	35 L (12 pz)	35 L (1 pz)	50 L (6 pz)
Waste bin with white swing lid	909010	909018	909035		909050
Black waste bin with black swing lid			909535	909536	
Wall bracket	779905	779905	779906	779906	779906

ECO RIF

SWING WASTE BIN

- **100% recycled polypropylene**
- Swing access to bin-lid can be used as sack holder
- Sold in 5 pc./box



50 L ▶



680 mm
345 mm
440 mm

WARNING: some recycled plastic products may have slight variations in colour shade



Lid With Swinging Flap



Grey/black swing lid waste bin 50 L

907451

RUF

PEDAL BIN

- Polypropylene
- Plastic opening mechanism (3, 6, 12 L); metal (20, 40 L)
- Plastic inner bucket with handle



3 L ▼



210 mm
175 mm

6 L ▼



265 mm
225 mm

12 L ▼



340 mm
270 mm

20 L ▼



420 mm
315 mm

40 L ▼



530 mm
380 mm

	3 L	6 L	12 L	20 L	40 L
Pedal bin (sold per unit)	906103	906106	906112	906120	906140
Pedal bin (sold in packs of multiple items)	906503	906506			

ESA

PEDAL BIN

- Polypropylene
- Plastic opening mechanism
- 5 L available also in black (Ref. 909106)
- Plastic inner bucket with handle



Colors available 5 L:



5 L ▼



240 mm
210 mm
200 mm

7 L ▼



280 mm
240 mm
230 mm

12 L ▼



330 mm
270 mm
270 mm

18 L ▼



390 mm
310 mm
305 mm

30 L ▼



475 mm
350 mm
360 mm

50 L ▼



550 mm
430 mm
423 mm

	5 L	7 L	12 L	18 L	30 L	50 L
White pedal bin (sold in packs of multiple items)	909105	909107	909112	909120	909130	909150
Black pedal bin (sold in packs of multiple items)	909106					

WASTE MANAGEMENT INDOOR AREAS

WASTE SORTING





MALTA

RECYCLING STATION



3 x 40 L ▶



960 mm
390 mm
790 mm

- Brushed stainless steel case
- Three s.steel push flaps marked with recycling symbols
- Metal coated frames
- Includes three inner sack holders from galvanized steel
- Front door opening with metal lock and triangular key
- Tubular 50x50 plinth with provision for ground fixing
- Optional, PVC pre-cut adhesive labels for waste sorting (p.75)



Inner sack holders



Customizable push flaps



Waste sorting stickers sold separately

Recycling station 3x40 L

789075



KOALA

RECYCLING STATIONS



- Brushed stainless steel or coated steel
- Front door opening with metal lock and triangular key
- Coloured frames to encourage waste separation
- Sign with recycling symbols
- Adjustable feet (5 cm max. height)
- As option, PVC pre-cut adhesive labels for waste sorting (p.75)
- Optional, four wheels Ø 40 mm as option (2 with breaks)



120 L ▶



1180 mm
585 mm
580 mm



Holds a 120 L waste container
CONTIVIA 2 Range
Page 106

60 L ▶



760 mm
485 mm
400 mm



Holds a 60 L waste bucket
OFFICE 60 - Ref. 114200
Page 71

Colors available 60 L:



Frames and signs:



Modular design:



Black coated steel case 120 L	789051
Brushed s.steel case 60 L	789020
Black coated steel case 60 L	789021
Grey frame	789032
Blue frame	789035
Yellow frame	789036
Red frame	789037
Green frame	789038
Brown frame	789039
Plastic recycling sign	789041
Paper recycling sign	789042
Glass recycling sign	789043
Mixed wastes sign	789044
Metal recycling sign	789045
Metal-plastic recycling sign	789046
Food waste recycling sign	789047
Four wheels kit Ø 40 mm (2 w/breaks)	789099

RUBIK EVO

RECYCLING WASTE BINS



80 L ▶

110 L



Inner sack holder



Opening 160x200 mm



4 wheels kit (2 w./breaks)

795 mm
425 mm
405 mm



Brown version with closable door
ideal for organic waste



OPENING
172x180 mm

Colors available:



Modular design



With stickers



- Housing and lid from powder-coated steel
- Coloured lids to encourage waste separation
- Pre-applied colored "skyline" stickers
- Inner sack holder
- Opening by upper door
- 4 height-adjustable feet
- Optional, four wheels Ø 40 mm as option (2 wheels with break)
- Optional, PVC pre-cut adhesive labels for waste sorting (page 75)



Recycling waste bin 80 L

GREY LID	WHITE LID	BLUE LID	YELLOW LID	RED LID	GREEN LID	BROWN LID
789292	789293	789295	789296	789297	789298	789299

Four wheels kit Ø 40 mm (2 w./breaks)

789099



ROXY CLASSIC

RECYCLING WASTE BIN - UPPER DOOR



Colors available:



Modular design • Optional, PVC pre-cut adhesive labels for waste sorting



AVAILABLE IN AR ON MEDIAL APP

"Classic" version: opening by upper door

- Housing and lid from powder-coated steel
- 4 height-adjustable feet
- Inner sack holder
- Four wheels Ø 40 mm as option (2 wheels with break)
- Optional, PVC stickers for waste sorting (page 75)



Four wheels kit Ø 40 mm (2 w/breaks)

789099

GREY BLACK	WHITE BLACK	BLUE BLACK	YELLOW BLACK	RED BLACK	GREEN BLACK	BROWN BLACK
789221	789231	789251	789261	789271	789281	789241

"ROXY DOOR" recycling waste bin 80 L

ROXY DOOR

RECYCLING WASTE BIN - FRONTAL DOOR



Brown version with closable door
ideal for organic waste



OPENING
172x180 mm



80 L

110 L

785 mm
450 mm
400 mm



Inner sack holder



Opening 160x200 mm



Lock



4 wheels kit

Colors available:

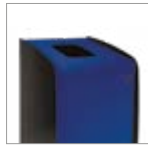

Optional
Union plate (Ref. 789210)
Signage Plaque (Ref. 789211)



Optional
Galvanised steel holder
(Ref. 789209)



"Door" version: opening by frontal door

- Housing and lid from powder-coated steel
- 4 height-adjustable feet
- Galvanised steel wire inner heel holder
- Lock with triangular key
- Four wheels Ø 40 mm as option (2 wheels with break)
- Optional, PVC stickers for waste sorting (page 75)
- Optional galvanised steel bucket (Ref. 789209)
- Optional union plate (Ref. 789210)
- Optional sign plate (Ref. 789211)



Optional union plate	789210
Optional sign plate	789211
Bucket in option	789209
Four wheels kit Ø 40 mm (2 w/breaks)	789099

GREY BLACK	WHITE BLACK	BLUE BLACK	YELLOW BLACK	RED BLACK	GREEN BLACK	BROWN BLACK
789222	789232	789252	789262	789272	789282	789242

"ROXY DOOR" recycling waste bin 80 L



ROME

WASTE PAPER BIN WITH A **CURVED** **SILHOUETTE** FOR SEPARATE COLLECTION

An **elegant recycling** station designed to facilitate separate collection in public spaces with a heavy flow of people. It stands out for the **refined material used**, powder-coated galvanized steel, with three collection points distinguishable on the basis of the type of waste to be allocated. Its sinuous shape and the use of the precious gloss paint give ROME a decorative as well as functional presence. Ideal for covered outdoor areas, entrances, offices, hotels, shopping centers and public facilities. Includes colored stickers to facilitate waste separation.



ROME

RECYCLING WASTE BIN



3 x 40 L ▶



720 mm
353 mm
965 mm



Three upper openings and sack holders



Optional, PVC pre-cut adhesive labels for waste sorting



Triangular key lock

Adhesive labels kit:

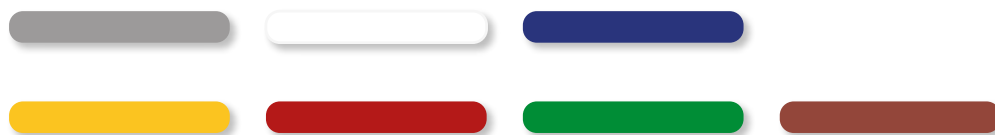

- Galvanized steel case
- Polyester powder coating matte black (RAL 9005)
- Three upper delivery openings
- Coloured adhesive labels for waste separation - included (x 7 colours)
- Holds three wire sack holders
- Adjustable feet
- Optional, PVC stickers for waste sorting (page 75)





BOB COLOR

THE EVERGREEN SOLUTION FOR WASTE COLLECTION

A product range that never goes out of fashion thanks to its **minimalist and elegant shapes** that make it evergreen. It stands out for its **versatility**.

This is our range of single-flush containers for separate collection in **medium-traffic indoor areas**.

Designed to be **arranged in series or in batteries** by means of a connecting bracket (sold as a separate accessory), BOB containers make it possible to create **functional and elegant collection islands**.

The dominant black body is defined by a melange of different lid colours - grey, blue, yellow, red, green and brown -.

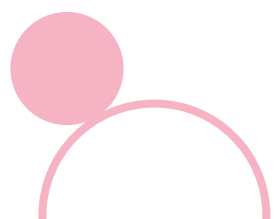

CARDBOB

OUR FIRST **100% RECYCLABLE** CARDBOARD WASTE BIN

Our first **100% recyclable** cardboard called CARDBOB.

You can combine the waste paper bin with the **painted metal lids** in the colour of your choice and with the **pre-punched stickers** to create a colourful recycling island.

The waste paper bin can be customised with personalization in **3 well-defined pantone colours**, (flexographic printing).

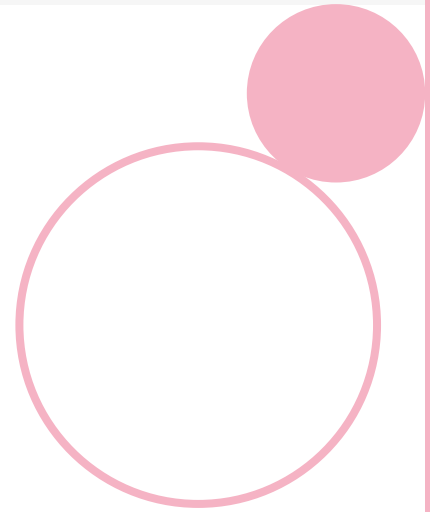

BOB COLOR

WASTE BIN



AVAILABLE IN AR ON MEDIAL APP



Colors available:

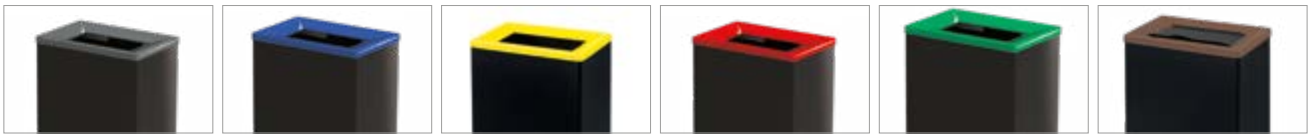

Modular design - Optional,
PVC pre-cut adhesive labels for waste sorting



Coloured lids for Bob and Cardbob:

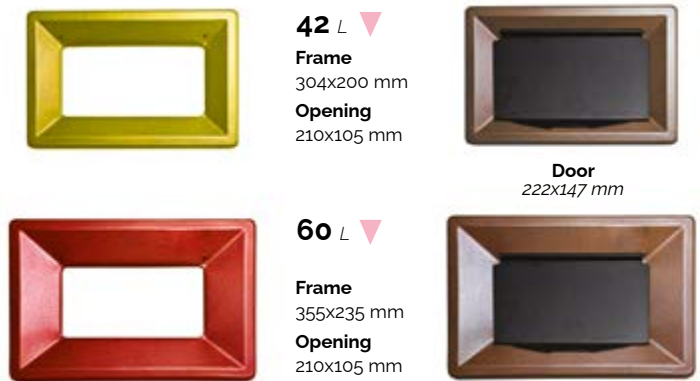

42 L ▾
Frame
304x200 mm
Opening
210x105 mm



Door
222x147 mm

60 L ▾
Frame
355x235 mm
Opening
210x105 mm



- Housing and lid from powder-coated steel
- Coloured frames for Bob and Cardbob
- Optional, clip to create recycling stands (cod. 790408)
- Optional, PVC stickers for waste sorting (p. 75)



Linking clips for buckets

790408



Linking clips for buckets

	BLACK	GREY	BLUE	YELLOW	RED	GREEN	BROWN
Bucket 42 L	790401						
Frame 42 L		790412	790415	790416	790417	790418	790414
Bucket 60 L	790402						
Frame 60 L		790432	790435	790436	790437	790438	790434

CARDBOB

WASTE BIN

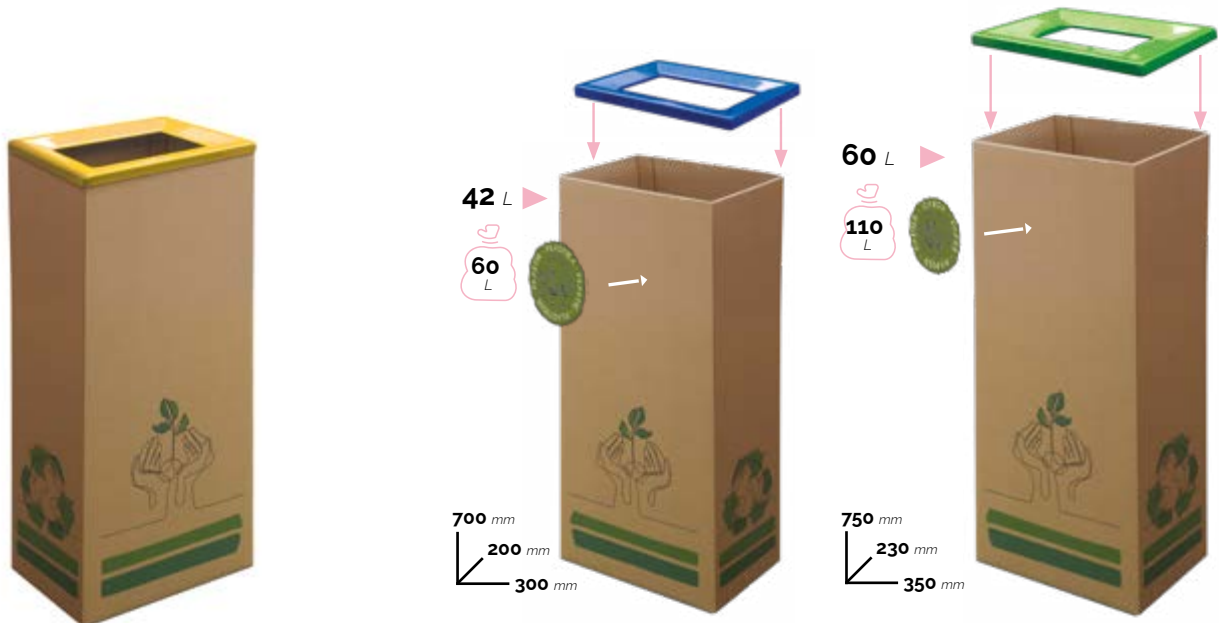

Colors available:

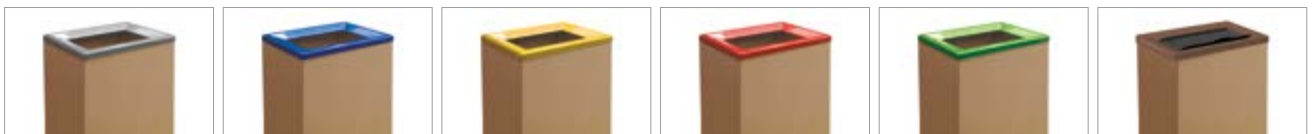

Waste collection stickers
available separately



Modular design • Optional, PVC pre-cut adhesive labels for waste sorting



Coloured lids for Bob and Cardbob, 42 L and 60 L - page 58:



- 100% recyclable cardboard
- Coloured frames for Bob and Cardbob
- Optional: pre-cut vinyl labels
- Possibility of graphic customisation



Cardboard bucket 42 L	801001
Cardboard bucket 60 L	801002
GENERAL WASTE sticker	711900
PLASTIC sticker	711901
PAPER sticker	711902
GLASS sticker	711903



GRISÚ

THE METAL CONTAINER SAFE, FUNCTIONAL AND ELEGANT

The **GRISÚ** metal container is designed with special attributes. Its shape and **safety** features make it suitable for use in public environments such as shopping centers, shops, restaurants and other meeting places.

The **CNPP certification** categorizes the product as **self-extinguishing and fire retardant**. This regulation is particularly important in places where the protection of customers and staff must be particularly preserved.

The **non-scratch rubber** base and the **low-slung lid** can help prevent accidents and damage to floors and surrounding surfaces.

Our fire container is designed to be not only functional, but also aesthetically pleasing. Its cylindrical shape gives the product composure.



GRISÙ VIP

AUTO-EXTINGUISHING WASTE BINS



GRISÙ VIP - "CLASSIC" VERSION



GRISÙ VIP COLOR - "COLORED" VERSION



Colors available:



- Housing made from powder-coated steel
- Lid made of brushed s.steel, with 100 mm lateral edge
- Coloured version to be assembled
- Special fire-extinguishing lid prevents fire from spreading
- Non-scratch rubber base ring
- CNPP certified as fireproof and fire retardant



GRISÙ VIP

Black steel waste bin with s.steel lid 50 L	770051
Black steel waste bin with s.steel lid 90 L	770052

GRISÙ VIP COLOR

	BLACK	WHITE	GREY	BLUE	YELLOW	RED	GREEN
Bucket 50 L	770051	770053					
Lid 50 L	770064	770067	770062	770065	770066	770067	770068
Bucket 90 L	770091	770093					
Lid 90 L	770065	770068	770062	770065	770066	770067	770068

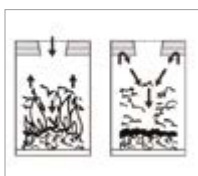

Flame-extinguishing process

GRISÙ

AUTO-EXTINGUISHING WASTE BINS



GRISÙ

Colors available:



GRISÙ COLOR

Colors available:



- Brushed s.steel or powder-coated steel, with 100 mm lateral edge
- Special fire-extinguishing lid prevents fire from spreading
- Non-scratch rubber base ring
- SILVER Version 50 L : double coating resembling s.steel
- **CNPP certified as fireproof and fire retardant**



GRISÙ

	15 L	30 L	50 L	90 L	120 L
Auto-extinguishing brushed s.steel waste bin	770000	770030	770010	770020	
Auto-extinguishing black steel waste bin	770001	770031	770011	770021	770041
Auto-extinguishing grey steel waste bin	770002	770032	770012	770022	770042
Auto-extinguishing silver double coating waste bin			772052		

GRISÙ COLOR

Auto-extinguishing Black-Grey waste bin			770014	770024	
Auto-extinguishing Black-Blue waste bin			770015	770025	
Auto-extinguishing Black-Yellow waste bin			770016	770026	
Auto-extinguishing Black-Red waste bin			770017	770027	
Auto-extinguishing Black-Green waste bin			770018	770028	

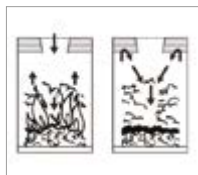

Flame-extinguishing process

TRISÙ

RECYCLING AUTO-EXTINGUISHING STATION



- The station comes with 3 auto-extinguishing bins
- Powder epoxy coated steel body and lid
- Self-extinguishing lid (designed to prevent fire from spreading)
- **50 L version CNPP certified as fireproof and fire retardant**



AVAILABLE IN AR ON MEDIAL APP



3x50 L ▶



590 mm
400 mm
1010 mm



Flame-extinguishing process

3x70 L ▶

840 mm
400 mm
1010 mm



Self extinguishing recycling station 3x50 L

770351

Self extinguishing recycling station 3x70 L

770371

GRISÙ MURALE

WALL MOUNTED AUTO-EXTINGUISHING WASTE BINS



- Housing made from powder-coated steel
- Lid made from powder-coated steel, with H 100 mm lateral edge
- Special fire-extinguishing lid prevents fire from spreading
- Wall mounting bracket from coated steel
- **CNPP certified as fireproof and fire retardant**



50 L ▶

Ø 140 mm



590 mm
335 mm

Colors available:



Flame-extinguishing process



Auto-extinguishing waste bin black steel 50 L

770211

Auto-extinguishing waste bin grey steel 50 L

770212

Auto-extinguishing waste bin white steel 50 L

770213

SLAIS

RECYCLING PAPER BIN



AVAILABLE IN AR ON MEDIAL APP

12 L ▶ SLAIS - 2 STREAMS

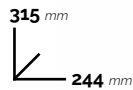
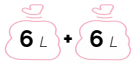

12 L ▶ SLAIS - 3 STREAMS

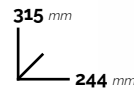
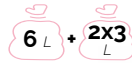

Inner buckets (6 L + 6 L)



Inner buckets (6 L + 2 x 3 L)



Lid with flaps (sold separately)

- Black coated steel
- Removable top to hide the waste bag and to facilitate bag change
- Suitable for hotel rooms, ship cabins as well as office workstation
- **2 STREAMS version:**
 - two removable colored polypropylene inner buckets (6 L + 6 L)
- **3 STREAMS version:**
 - three removable colored polypropylene inner buckets (6 L + 2 x 3 L)
 - optional, lid with flaps marked PAPER, FOOD, PLASTIC



Recycling paper bin 12 L (6+ 6 L)	770146
Recycling paper bin 12 L (6+ 2x3 L)	770141
Separator lid with marked flaps	770191

MULTIFLUX

RECYCLING PEDAL BIN

2x12 L ▶



430 mm
382 mm
405 mm



Two inside buckets

- Fingerprint-proof brushed stainless steel body
- Silent close lid in polypropylene and stainless steel
- Tuck-away bag hiding system
- Individually operable flows (only for Vers 3x15)
- Built-in lateral handles for easy handling
- Polypropylene inner buckets with handle
- Non-scratch ABS base



3x12 L ▶



430 mm
382 mm
593 mm



Three inside buckets

3x15 L ▶



430 mm
370 mm
585 mm



Three inside buckets



Opening separate streams

2x30 L ▶



636 mm
459 mm
495 mm



Recycling pedal bin 2x12 L	106503
Recycling pedal bin 3x12 L	106500
Recycling pedal bin 2x30 L	106505
Recycling pedal bin 3x15 L	112500

TRIFLUX

WASTE SORTING TRIPLE BAG HOLDER

3x110 L ▶



970 mm
420 mm
860 mm



Wheels with brake



Ideal for recycling

- White powder epoxy coated steel frame
- Three compartments (each bag counts 110 L)
- Four rotating non-marking wheels (two with brakes)
- Lateral rubber dumpers



Triple bag holder white steel 3 x 110 L	108010
---	--------

STATION

RECYCLING WASTE BIN



STATION DUO 2 STREAMS

2x50 L ▶



750 mm
450 mm

STATION TRIO 3 STREAMS

3x35 L ▶



750 mm
450 mm

Colorful adhesive label kit



- Coated steel body and brushed s.steel lid
- **STATION DUO:**
 - two inner buckets in galvanized steel
 - bucket capacity: 50 L / total capacity: 100 L
- **STATION TRIO:**
 - three inner buckets in galvanized steel
 - bucket capacity: 35 L / total capacity: 105 L
- Optional KIT 5 coloured adhesive labels (REF. 701093)
- Plastic bottom ring



Black recycling bin + galva steel buckets 2x50 L **790840**

Black recycling bin + galva steel buckets 3x35 L **790830**

Colorful adhesive label kit (x5) **701093**

CASPER

SPECIAL RECYCLING WASTE BINS



Colorful adhesive label kit

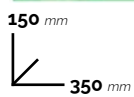

- Lid and base from coated steel
- Transparent tube from polycarbonate
- Absorbent round disc at the base
- Easy to check the content
- Stickers sold separately



Opening

Green bin 10 L	774500
Grey bin 10 L	774502
Exhausted batteries sticker	774510
Lamps sticker	774511
Caps sticker	774512
Writing instruments sticker	774513
Inkjet cartridges sticker	774514

BLOOM

MOBILE "PLASTIC SECOND LIFE" WASTE CONTAINER



- Polypropylene (second life) 100% recyclable
- Weather, chemical and UV resistant
- Two wheels bin with 270° opening lid
- Integrated ergonomic rear carrying handle and 4 fixed bag-holding hooks



Handle



4 fixed bag-holding



Stackable



Wheels and axles already assembled

80 L



780 mm
500 mm
450 mm

ø 120 mm

Colors available:



GREY-BLUE	GREY-YELLOW	GREY-RED	GREY-GREEN
720805	720806	720807	720808

Waste container 80 L

BLOOM PUSH

PUSH LID "PLASTIC SECOND LIFE" WASTE CONTAINER



- Polypropylene (second life) 100% recyclable
- Weather and chemical resistant
- Two wheels and a bell-shaped lid with PUSH opening
- Integrated ergonomic rear carrying handle and 4 fixed bag-holding hooks



Handle



4 fixed bag-holding



Stackable



Wheels and axles already assembled

100 L



950 mm
540 mm
490 mm

ø 120 mm



PUSH opening

Colors available:



GREY-BLUE	GREY-YELLOW	GREY-RED	GREY-GREEN
720905	720906	720907	720908

PUSH lid waste container 100 L

OFFICE 90

RECYCLING WASTE CONTAINER

90 L ▶



755 mm
510 mm
285 mm



835 mm
520 mm
295 mm



930 mm
520 mm
295 mm



90 L ▶

760 mm
520 mm
285 mm

CUP COLLECTOR RECYCLING CONTAINER

PVC internal tubes that keep streams separated

Eight openings allow cups to stack and store. One hole for stirrers.

Holds up to 1.600 cups max diameter 70 mm

Clips to link the buckets

- Bucket and lids made of polypropylene
 - Sturdy 90 L grey bucket
 - Interchangeable coloured lids for effective waste separation
 - Compact design to better fit in small spaces
-

Grey bucket 90 L	102200
Waste bin with handle lid 90 L	102203
Waste bin with blue hole lid 90 L	102205
Waste bin with yellow hole lid 90 L	102206
Waste bin with red hole lid 90 L	102207
Waste bin with green hole lid 90 L	102208
Waste bin with swing lid 90 L	102210
Cup collector recycling bin	102211
Clips to link the buckets	102220

OFFICE 60

RECYCLING WASTE CONTAINER

60 L ▶



580 mm
450 mm
310 mm



660 mm
450 mm
320 mm



780 mm
460 mm
330 mm



860 mm
470 mm
325 mm



150 mm
470 mm
325 mm



Hooks for trolley

AVAILABLE IN AR ON MEDIAL APP

- Body and lid made in Polypropylene
- Grey bucket with built-in handles (60 lt capacity)
- Seven different lids for effective waste separation
- Compact design to better fit in small spaces
- Wheeled trolley to combine multiple bins in one perfect storage solution
- Ideal for offices or food service industry



Grey bucket 60 L	114200
Waste bin trolley	114201
Trolley linking hooks	114202
Waste bin with blue upper opening lid 60 L	114205
Waste bin with yellow upper opening lid 60 L	114206
Waste bin with red upper opening lid 60 L	114207
Waste bin with green upper opening lid 60 L	114208
Waste bin with grey push opening lid 60 L	114210
Waste bin with blue front opening lid 60 L	114215
Waste bin with yellow front opening lid 60 L	114216

SLIM

PEDAL BIN

- Polypropylene
- Metal opening mechanism
- Plastic inner sack holder
- 60 L version available in several colors for waste sorting
- Sold singly (assembled) or per pack (unassembled)



Colors available:



	SOLD PER UNIT			SOLD PER BOX		
	10 L	25 L	60 L	10 L	25 L	60 L
Black pedal bin	909811			909810		
Grey pedal bin	909911	909926	909961	909910	909925	909960
Grey-blue pedal bin			909975			909965
Grey-yellow pedal bin			909976			909966
Grey-red pedal bin			909977			909967
Grey-green pedal bin			909978			909968

RIF BASIC

SWING WASTE BIN

- High-density polypropylene plastic
- Swing access to bin-lid can be used as sack holder
- Wall mounting kit sold separately
- Sold in multi-pack (6 pcs)



Colors available:



Ref. 779906 (page 44)
Wall bracket 35 / 50 L

Waste bin with colored swing lid - 50 L

BLUE	YELLOW	RED	GREEN
909055	909056	909057	909058

CLIPPY

"PLASTIC SECOND LIFE" TRASH CAN



- Polypropylene (second life) 100% recyclable
- Lid equipped with clip closures
- Modern design, it fits well in all environments
- Lids colors available to encourage waste separation



Colors available:



25 L



Clip closure

450 mm
400 mm

GREY-BLUE	GREY-YELLOW	GREY-RED	GREY-GREEN
720205	720206	720207	720208

Trash can 25 L

DUCK

"PLASTIC SECOND LIFE" TRASH CAN WITH SWING LID



- Polypropylene (second life) 100% recyclable
- Weather, chemical and UV resistant
- Swinging beak door and lid with anti-random mechanism
- Lid with reinforced hinges for 270° opening
- Ergonomic handle with vertical locking



Colors available:



Swinging Lid



Ergonomic handle



Grip for emptying



Stackable

35 L



520 mm
370 mm
370 mm

25 L



410 mm
370 mm
370 mm



GREY-BLUE	GREY-YELLOW	GREY-GREEN	GREY-BROWN
720115	720116	720118	720119
720105	720106	720108	720109

Swinging lid trash can 35 L

Swinging lid trash can 25 L

STIK

RECYCLING STICKERS



- Pre-cut adhesive labels made from gloss PVC
- Can be applied on all types of surfaces, both plastic and metal
- Useful to encourage waste sorting
- Suitable for indoor and outdoor use
- Extra texts, icons and colours can be customised on request



	General Waste	Plastic	Paper	Glass	Food waste
Recycling stickers horizontal 200x130 mm	701070	701071	701072	701073	701074
Recycling stickers vertical 205x295 mm	701050	701051	701052	701053	701054

STIK

RECYCLING STICKERS



- Pre-cut adhesive labels made from matt white or black vinyl
- New versions with 3M technology
- Useful to encourage waste sorting
- Suitable for indoor and outdoor use
- Extra texts, icons and colours can be customised on request



3M 3M Technology



SCAN THIS QR CODE TO SEE THE VIDEO TUTORIAL



STIK

RECYCLING STICKERS



White or black vinyl

GENERICO
PLASTICA
CARTA
VETRO
ORGANICO
RICICLABILE
NON RICICLABILE

White or black vinyl

GENERAL WASTE
PLASTIC
PAPER
GLASS
FOOD WASTE
RECYCLABLE
NON-RECYCLABLE

Icons



White or black vinyl

AUTRES DECHETS
PLASTIQUE
PAPIER
VERRE
COMPOSTABLE
RECYCLABLE
NON RECYCLABLE
EMBALLAGES

White or black vinyl

RESTMULL
PLASTIK
PAPIER
GLAS
BIOMÜLL
RECYCELBAR
NICHT RECYCELBAR

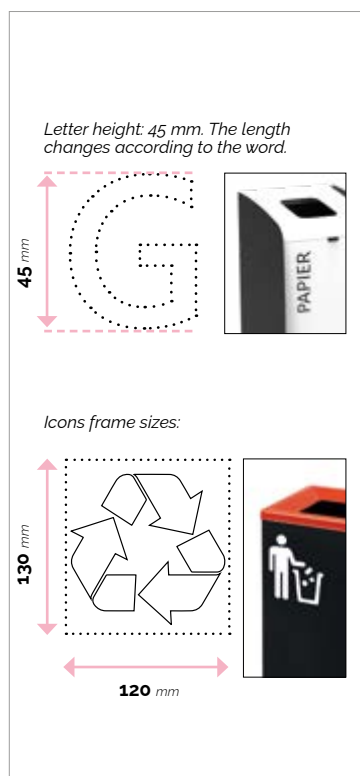

BLACK VINYL	ICON	ITA	ENG	FRA	DEU
General waste (Black)	711210	711300	711310	711320	711330
Plastic (Black)	711211	711301	711311	711321	711331
Paper (Black)	711212	711302	711312	711322	711332
Glass (Black)	711213	711303	711313	711323	711333
Food waste (Black)	711214	711304	711314	711324	711334
Recyclable (Black)	711216	711306	711316	711326	711336
Non-recyclable (Black)	711217	711307	711317	711327	711337
Emballages (Black)	711218			711328	

WHITE VINYL	ICON	ITA	ENG	FRA	DEU
General waste (White)	711200	711100	711110	711120	711130
Plastic (White)	711201	711101	711111	711121	711131
Paper (White)	711202	711102	711112	711122	711132
Glass (White)	711203	711103	711113	711123	711133
Food waste (White)	711204	711104	711114	711124	711134
Recyclable (White)	711206	711106	711116	711126	711136
Non-recyclable (White)	711207	711107	711117	711127	711137
Emballages (White)	711208			711128	

WASTE MANAGEMENT

INDOOR AREAS

**COMMON
AREAS**





HOUDINI

FOLDABLE WASTE BIN WITH AUTOMATIC LID



Sensor lid opening



Sensor controls on lid



- Satin-finished anti-fingerprint stainless steel body and ABS lid
- Foldable design for easy assembly and disassembly
- Sensor operation
- Plastic bag holder ring
- Feet height 16.5cm
- Operation with 4 AA batteries (not included)
- Fall-proofed packaging



40 L

60 L

Foldable waste bin with automatic lid

109240

109260

APOLLO

PEDAL PUSH WASTE BIN

52 L ▶



880 mm
415 mm

690 mm
310 mm



Plastic foot pedal with metal reinforcement

- Polished stainless steel
- Pedal-operated stainless steel lid
- Easy-grip side handles for easy handling
- Removable galvanized steel inner liner with handle
- Non-skid ABS base



Polished stainless steel pedal bin 52 L

106021

APOLLINO

PEDAL PUSH WASTE BIN

40 L ▶



790 mm
360 mm

505 mm
323 mm



Plastic pedal

- 201 Brushed s.steel "finger print"
- Pedal-operated door with no hand contact
- Retractable head for access to the bucket
- Galvanised steel inner bin
- Plastic base



Opening and internal bucket

"Finger print" brushed 201 s. steel pedal bin 40 L

112001

APOLLO

PUSH WASTE BIN

52 L ▶



880 mm
415 mm

690 mm
610 mm

Colors available:



- Polished or brushed stainless steel body
- Powder epoxy coated steel body
- Push flap opening from stainless steel
- Easy-grip side handles for easy handling
- Removable galvanized steel inner bucket with handle
- Non-skid ABS base



Polished stainless steel push bin 52 L	106031
Brushed stainless steel push bin 52 L	106032
Black coated steel push bin 52 L	106033

APOLLINO

PUSH WASTE BIN

40 L ▶



740 mm
350 mm

540 mm
310 mm

Colors available:



- Brushed s.steel or powder epoxy coated steel
- Stainless steel door with push opening
- Removable lid with push flap opening
- Removable galvanized steel inner bucket with handle
- Non-skid ABS base



Brushed s.steel push waste bin 40 L	106051
Black waste bin with s.steel push lid 40 L	106053

STORICO

PUSH WASTE BIN

50 L ▶



940 mm
240 mm
325 mm

Colors available:



- Polished s.steel or coated steel
- Push opening trap
- Stainless steel opening
- Suitable for wall mounting



With ashtray

Waste bin with black bucket 50 L	790057
Waste bin with black bucket and ashtray 50 L	790457
Waste bin with s.steel bucket 50 L	790557





STORICO

SWING WASTE BINS

50 L ▶



940 mm
240 mm
325 mm

Colors available:



- Polished s.steel or coated steel
- Swinging opening
- Stainless steel swinging opening



Waste bin with black bucket 50 L **790063**

Waste bin with s.steel bucket 50 L **790563**

SWINGO

SWING WASTE BINS

50 L ▶

Cylindrical



720 mm
410 mm

60 L ▶

Oval



720 mm
390 mm
495 mm

- Stainless steel body, with polished finish
- ABS lid with stabilizing counter balance
- Oval or cylindrical version
- Polypropylene inner bucket with handle



Cylindrical swing waste bin s.steel 50 L **109777**

Oval swing waste bin s.steel 60 L **109796**

BASCULINO

SWING WASTE BIN

52 L ▶



720 mm
380 mm



Swing Opening

- Polished stainless steel
- Swing lid in polished stainless steel
- Galvanized inner bucket with handle
- Non-skid rubber base



Swing waste bin polished stainless steel 52 L **606091**

GRISÙ KRIL

TRANSPARENT AUTO-EXTINGUISHING WASTE BIN

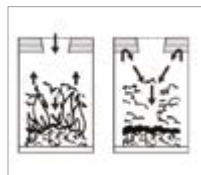

Flame-extinguishing process

- Lid and base from coated steel
- Transparent tube from PMMA
- Special fire-extinguishing lid prevents fire from spreading
- **Functional design makes it easy to view the contents**
- Non-skid rubber base



Transparent fireproof waste bin 80 L	774021
Transparent fireproof waste bin 110 L	774041

STORICO KRIL

TRANSPARENT WASTE BINS



- Powder epoxy coated steel frame
- Front and lateral sides from transparent polycarbonate
- **Functional design makes it easy to view the contents**
- Push opening in polished s.steel
- Freestanding or wall mounted (screws not included)



Transparent waste bin 50 L	774057
----------------------------	---------------



FLUXY

BAG HOLDER

110 L ▶



850 mm
550 mm
410 mm

- White powder epoxy coated steel tubes
- Non scratch 4-points stand
- Bag held in place by tautness
- Info board available as option
- Customizable with recycling stickers sold separately (page 75)



Board
250 x 20 x 190 mm



110 L bag



Opening 400x370 mm

Bag holder white steel 110 L

789123

Information board white steel

789133

FLIP

SWING PAPER BIN

7 L ▶



275 mm
200 mm

- AISI 304 polished s.steel
- Swinging lid
- Upper ring to hide the bag
- Ideal for hotel use



Swinging lid



Swing paper bin 7 L

906607

BOBBINO

PAPER BIN

8 L ▶



345 mm
245 mm

- Body from polished stainless steel
- Upper ring to hide the bag
- Plastic inner bucket with handle
- Rubberized base



Polished s.steel paper bin 8 L

906701

GETSI INOX

PAPER BIN

11 L ▶



280 mm
230 mm

- Stainless steel body
- Several finishes available
- Sleek and elegant design

Colors available:



Paper bin brushed s.steel 11 L

103034

Paper bin polished s.steel 11 L

103035

POIS

PERFORATED PAPER BIN



14 L ▶



300 mm
240 mm

- Powder epoxy coated steel
- Compact and sleek design



Paper bin black steel 14 L

770111

DOT

PERFORATED PAPER BIN

13 L ▶



280 mm
220 mm

- Powder epoxy coated steel
- Compact and sleek design



Perforated paper bin (sold singly)

150131

Perforated paper bin (20 pcs per pack)

150531

PALACE

PAPER BIN

13 L ▶



310 mm
230 mm

- Metal body covered by black faux leather
- Removable stainless steel rim to hide plastic bag
- Non-scratch rubber base



Paper bin faux leather 13 L

103050

GETSI CLASSIC

PAPER BIN

12 L ▶



305 mm
225 mm

Colors available:



- Powder epoxy coated steel body
- Non-scratch rubber base
- Easy to empty and clean
- Stylish under a desk



Paper bin white 12 L

103030

Paper bin black 12 L

103031

BIG



ASHBIN

50 L ▶

60 L

400

755 mm
435 mm



Sand optional



- Polished stainless steel body with galvanized steel inner bucket
- Steel ashtray with black coated steel grid
- Plastic bottom ring prevents damage to the floor
- Sand bag on request (ref. 799640)
- Suitable for use in covered outdoor areas



Ashbin polished s.steel 50 L

790610

GRISÙ



AUTO-EXTINGUISHING ASHBIN

- Powder epoxy coated steel
- Ashtray with grid (1kg sand included)
- Auto-extinguisher lid
- Plastic bottom ring prevents damage to the floor
- Suitable for use in covered outdoor areas



30 L ▶

100

815 mm
260 mm



50 L ▶

250

810 mm
340 mm



90 L ▶

300

970 mm
405 mm



Ashbin black coated steel

30 L	50 L	90 L
775031	775051	775091

Ashbin grey coated steel

775032	775052	775092
--------	--------	--------

DOS



ASHBIN

19 L ▶



730 mm
265 mm



- Stainless steel or epoxy coated steel body
- Self-extinguishing lid with ashtray on top
- Galvanized steel inner bucket on request
- Plastic bottom ring prevents damage to the floor



Colors available:



Ashbin polished s.steel 19 L **775020**

Ashbin black coated steel 19 L **775021**

Bucket in option **775029**

QUADRO 27



ASHBIN

27 L ▶



710 mm
200 mm
300 mm



- Powder epoxy coated steel
- Removable top made from stainless steel
- Ash container made from galvanized steel
- Inner bucket on request



Ashbin black coated steel 27 L **790018**

Inner bucket as option **790001**

MINI

ASHBIN



11 L ▶



600 mm
200 mm

- Polished stainless steel
- Powder epoxy coated steel
- Ashtray with black grid
- Comes without inner bucket



Colors available:



Ashbin polished s.steel 11 L

790613

Ashbin black epoxy coated steel 11 L

790113

CÉNERE

ASHBIN



22 L ▶



650 mm
260 mm
260 mm

- Polished stainless steel or powder epoxy coated steel
- Galvanized steel inner bucket 22 L
- Auto-extinguishing lid
- Wide opening with rubber edges
- Plastic bottom ring prevents damage to the floor



Colors available:



Ashbin polished s. steel 22 L

106011

Ashbin black coated steel 22 L

106012



Ashtray

MAXIPUSH

PUSH TRASH CANS

- Polypropylene
- Push door access to bin
- Built-in side handles for easy handling
- Ashtray on top only available in the 120 L version



120 L ▶



970 mm
630 mm

80 L ▶



780 mm
555 mm



Ashtray

Push waste container with grey lid 120 L **114120**

Push waste container grey 80 L **114125**

GABIPUSH

PUSH TRASH CANS

- Body and lid in polypropylene
- Push opening
- Easy-grip side handles for easy handling



110 L ▶



890 mm
550 mm

80 L ▶



760 mm
480 mm



Opening

Push trash can manganese grey 110 L **102010**

Push trash can manganese grey 80 L **102011**

CUB

TRASH CANS

- Polypropylene
- Easy-grip side handles for easy handling
- Heavy duty and easy to maintain



80 L ▶



685 mm
505 mm



615 mm
505 mm



610 mm
505 mm



Trolley

Trash can with flat lid grey 80 L	114100
Trash can grey 80 L	114105
Trash can with funnel shaped lid grey 80 L	114110
Trolley	114115

BIRILLO

TRASH CAN

45 L ▶



Ø 400 mm



490 mm
310 mm

- Polypropylene
- Sold 4 pcs per box



Trash can black 45 L

102015

GRISÙ PLASTIC

FIRE-RETARDANT PLASTIC PAPER BIN

- Fire-retardant polypropylene (Class V0 relative to the UL 94 norm)
- **CNPP certified**
- Ideal for hotel rooms and offices



8 L ▶

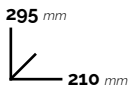

14 L ▶

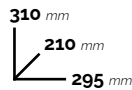

Colors available:



Fire-retardant paper bin cylindrical beige 8 L **114010**

Fire-retardant paper bin cylindrical black 8 L **114011**

Fire-retardant paper bin rectangular black 14 L **114021**

Fire-retardant paper bin rectangular grey 14 L **114022**

BASKET

PAPER BINS

12 L ▶

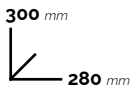

- 100% Recycled polypropylene
- Easy to use and clean

WARNING: some recycled plastic products may have slight variations in colour shade



12 L ▶

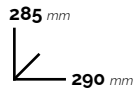

- Polypropylene plastic body
- Easy to use and clean

Colors available:



Paper bin perforated white 12 L **906400**

Paper bin perforated black 12 L **906401**

Paper bin perforated grey 12 L **906402**

9 L ▶

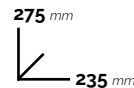

- 100% Recycled polypropylene
- Easy to use and clean

WARNING: some recycled plastic products may have slight variations in colour shade



Black paper bin (sold singly) **907092**

Black paper bin (24 pcs/pack) **907292**

CÉNERE PLAST



ASHBIN

25 L ▶

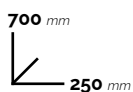

- Polypropylene body
- Fireproof plate



Black polypropylene ashbin 25 L

710009

SAND



BAG OF SAND

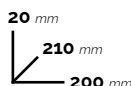

- High-quality sand for ashtrays (1 Kg)
- Ensures quick fire extinguishing and stops smell from spreading
- We recommend to change the sand once a week



Bag of white sand 1 Kg

799640

RAINBOW



DUSTPAN WITH HANDLE



- Galvanized steel or epoxy coated steel
- Galvanized dustpan (12 pcs per box)
- Unicolor dustpan (12 pcs per box)
- Mixed colour version (12 pcs per box - 3 pcs per color)



Colors available:



Zincked steel dustpans w/long handle **718270**

Mixed coloured dustpans w/long handle **718275**

Blue dustpans w/long handle **718375**

Yellow dustpans w/long handle **718376**

Red dustpans w/long handle **718377**

Green dustpans w/long handle **718378**

WASTE MANAGEMENT

OUTDOOR AREAS

This area dedicated to WASTE MANAGEMENT is oriented towards solutions for **OUTDOOR SPACES**.

The classification in this section is always based on the **intended use** of the product through the identification of the subcategories WASTE SORTING and COMMON AREAS.

The section on **WASTE SORTING** includes an accurate offer of street furniture separate collection stations that promote cleanliness and orderliness in the environment.

The **COMMON AREAS** sub-chapter is designed to contribute to urban decorum through the presentation of waste collection stations in city contexts (parks, city centers, pavements, gardens, etc.).





WASTE MANAGEMENT

OUTDOOR AREAS

WASTE SORTING







TRYVIA

PARKS ARE THE SOUL OF A CITY: OUTDOOR CONTAINERS FOR SEPARATE COLLECTION

Tryvia, the winged container. Attractive, colourful and eye-catching. The Tryvia waste station facilitates waste sorting thanks to the **cylindrical flows made of perforated sheet metal** in the shape of a wave, allowing **the type of waste** to be deduced inside to be guessed through colour and perforation. An additional highlight is the keyed lock, which allows for **safe and convenient** management of emptying, preventing unauthorized access. The **lively and curious** style in combination with **functionality** will give joyful nuances to the target environment. The new litter bin is distinguished by its clean and modern design, which blends harmoniously with urban architecture, contributing to a more decorous and orderly environment.



TRYVIA

OUTDOOR CONTAINERS FOR SEPARATE COLLECTION



3 FLUX

105 L ▶
(3 x 35 L)



4 FLUX

140 L ▶
(4 x 35 L)



Ashtray optional



Colors available:



Opening canopies



Perforated base

AVAILABLE IN AR ON MEDIAL APP

- Steel painted with primer base galvanising + coloured polyester paint
- Perforated base ready for floor installation (mandatory)
- Two options: three or four recycling bins (- 35 L each)
- Canopies, blocked by a lid or ashtray (optional REF. 789409)
- Customisable colour composition
- Lock with triangular key



Outdoor containers (3 bins) - 105 L

789400xxx

Outdoor containers (4 bins) - 140 L

789401XXXX

Ashtray for Tryvia

789409

STATION CITY

RECYCLING ASHBIN



- Powder epoxy coated galvanized steel body
- Three galvanized inner buckets 35 lt each (105 lt tot.)
- Ashtray fixed by a small chain
- Triangular key lock for added security
- Compulsory ground anchoring at 3 points
- Optional, PVC pre-cut adhesive labels for waste sorting (p. 75)



AVAILABLE IN AR ON MEDIAL APP

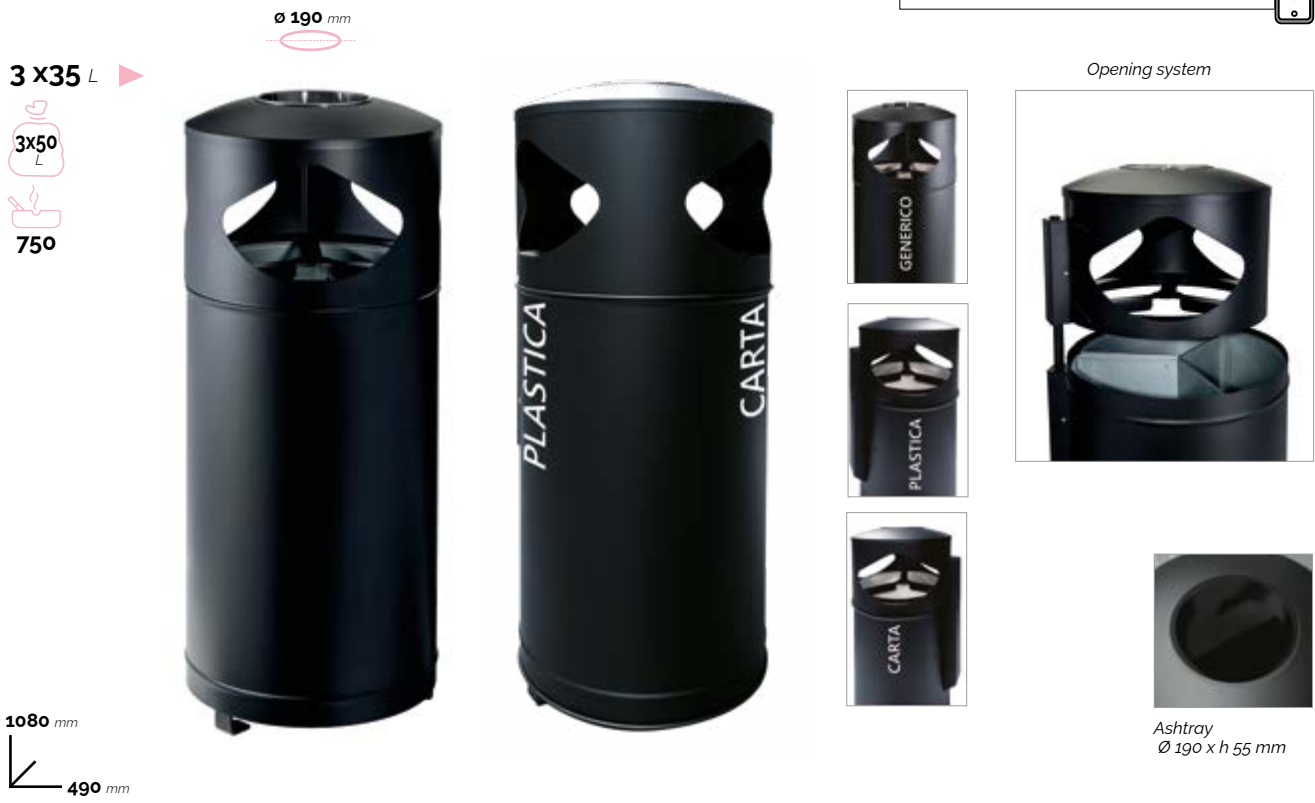

Recycling ashbin 3x35 L

776000



AMSTERDAM

RECYCLING STATIONS



3 FLUX

120 L
(3 x 40 L)



1120 mm
380 mm
725 mm

2 FLUX

120 L
(2 x 60 L)



1120 mm
380 mm
725 mm

Colors available:



Triangular key lock



Ashtray optional
REF. 789390 (P. 115)



Steel wire sack holders
(3x40 L o 2x60 L)



(Optional) PVC pre-cut adhesive labels for waste sorting

AVAILABLE IN AR ON MEDIAL APP

- Steel case (sheet steel thickness 2 mm)
- Primer finishing + Polyester powder coating (manganese grey RAL 7021)
- Coloured frames to encourage waste separation (295 x 200 mm)
- Holds 3 or 2 steel wire sack holders (3x40 L or 2x60 L)
- Tubular 50x50 plinth with provision for ground fixing



GREY BLUE YELLOW RED GREEN BROWN

Recycling station 3 streams (3x40 L) **789310**

Recycling station 2 streams (2x60 L) **789312**

Coloured frames (295 x 200 mm) **789332** **789335** **789336** **789337** **789338** **789339**



VERONA

THE RECYCLING STATION WITH A **COMPACT** AND **ESSENTIAL** DESIGN

Capacity, functionality and modernity are the hallmarks of our compartmentalized waste container for waste separation in medium and high traffic indoor and covered outdoor areas.

VERONA features a **compact and essential design**. The shining different types of waste supported by different steel wire holders, with 120 or 160 L total maximum capacity.

The VERONA container makes it possible to create a collection station with elegant features.



VERONA

RECYCLING STATIONS



VERONA 3 FLUX

120 L
(3 x 40 L)



1094 mm
326 mm
1018 mm

VERONA PLUS 4 FLUX

160 L
(4 x 40 L)



1094 mm
376 mm
1018 mm

Front opening size

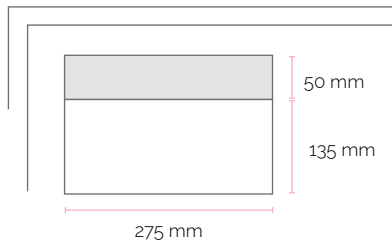

Front opening size

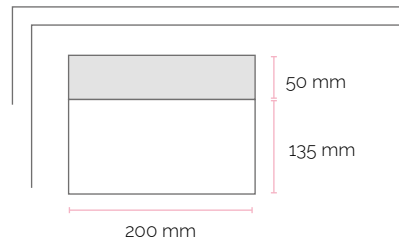

Triangular key lock



Ashtray optional
REF. 789390 (P. 115)



Steel wire sack holders
(3x40 L o 4x40 L)



(Optional) PVC pre-cut adhesive labels for waste sorting

AVAILABLE IN AR ON MEDIAL APP

- Galvanized steel case
- Polyester powder coating (RAL 7021)
- 3 or 4 front openings, complete with colored stickers
- Holds three steel wire sack holders (3 x 40 L) - VERONA
- Holds four steel wire sack holders (4 x 40 L) - VERONA PLUS
- Tubular 50x50 plinth with provision for ground fixing
- Optional, PVC pre-cut adhesive labels for waste sorting (p. 75)



**SUITABLE
PRODUCT
ALSO FOR
INDOOR AREAS**

VERONA - Recycling station 120 L (3x40 L)

789300

VERONA PLUS - Black recycling station 160 L (4x40)

789301

TONDO



SACK HOLDER AND SACK HOLDER WITH LID

- Polyester powder coated steel body
- Bag held securely by elastic belt
- Wall or post mounted fixing



Colors available:

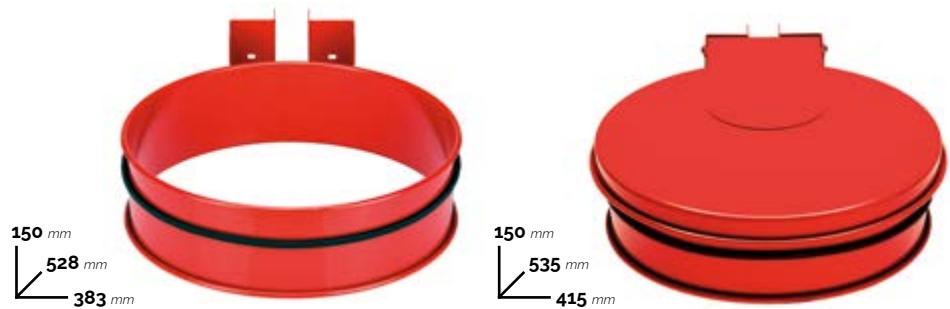

	BLUE	MANGANESE GREY	GREEN	YELLOW	RED
Bag holder	601001	601002	601003	601004	601005
Bag holder with lid	601011	601012	601013	601016	601015

WALL BRACKET AND ROUND POST ADAPTERS (NOT INCLUDED)

- Polyester powder coated galvanized steel body and lid



Wall bracket

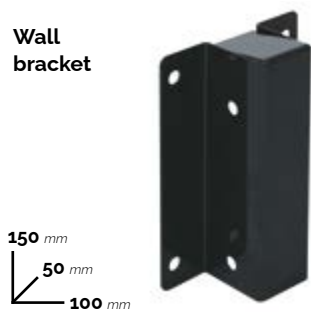

Adapter for Ø 200 mm post

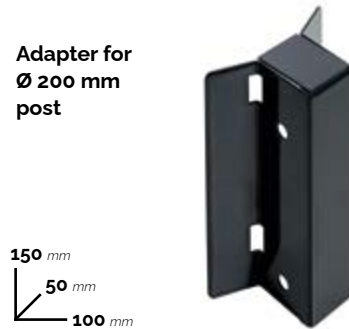

Adapter for Ø 50/60 mm post

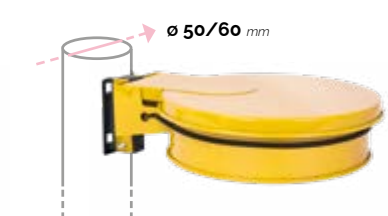
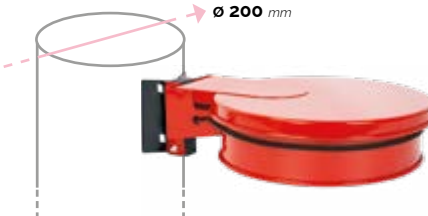
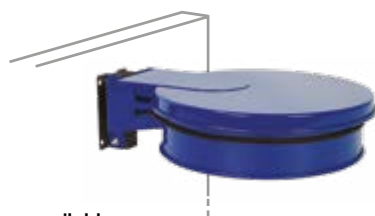

Colors available:



To be installed with:



	BLUE	MANGANESE GREY	GREEN
Wall mounting holder	601006	601007	601008
Adapter for Ø 200 mm post		601052	
Adapter for Ø 50/60 mm post		601057	

TONDO

POSTS, HOLDERS AND ACCESSORIES



• Powder epoxy coated galvanized steel body and lid



Ground fixing post

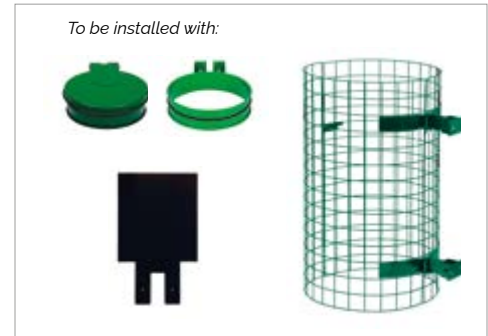

MANGANESE GREY

Ground fixing post

601028

On stand base (single holder)

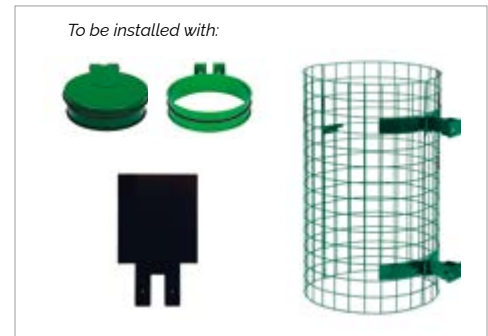

MANGANESE GREY

Free-standing base (single holder)

601025

Ground fixing base post (single holder)

Colors available:

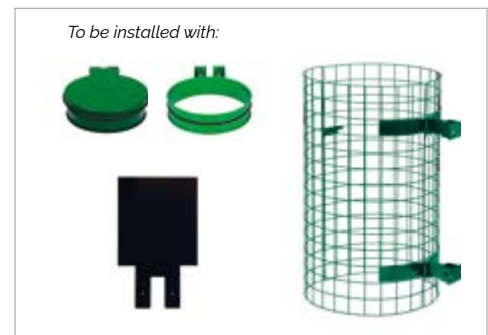
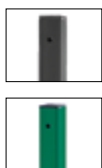

MANGANESE GREY

GREEN

Post with ground fixing base

601038

601039

TONDO

POSTS, HOLDERS AND ACCESSORIES



• Powder epoxy coated galvanized steel body and lid



Post & base for double / triple holder



920 mm
680 mm
440 mm

Post bracket with double holder

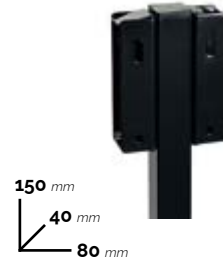

150 mm
40 mm
80 mm

Post bracket with triple holder



200 mm
160 mm

To be installed with:



MANGANESE GREY

Post & base for double or triple holder	601030
Post bracket with double holder	601062
Post bracket with triple holder	601020T

N.B.: One grid per pole applicable

Colors available:

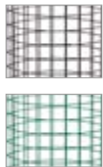

700 mm
410 mm



Info board



320 mm
10 mm
260 mm

MANGANESE GREY GREEN

Grid for sack holder	601082	601083
Info board	601035	

TRESPY

BAG HOLDER LITTER BIN



110 L ▶



850 mm
510 mm

Colors available:



Opening and sack holder



Stackable

- PEHD (second life) 100% recyclable
- Integrated heel clip ring
- Cheap, practical, adaptable, light and easy to use
- Particularly suitable for differential waste collection
- Available in different colours



GREEN	GREY	GREY-BLUE	GREY-YELLOW	GREY-RED	GREY-GREEN
720503	720500	720505	720506	720507	720508

Bag holder litter Bin 110 L

CONTIVIA 2

PLASTIC WASTE CONTAINER ON 2 WHEELS

120 L ▼



240 L ▼



360 L ▼



Colors available:

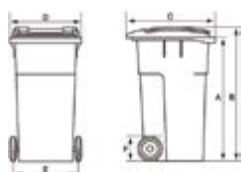

	A (mm)	B (mm)	C (mm)	D (mm)	E (mm)	F (mm)	WEIGHT (Kg)	MAX LOAD (Kg)
120 L	875 mm	927 mm	543 mm	480 mm	480 mm	200 mm	10,4 Kg	48 Kg
240 L	1007 mm	1062 mm	715 mm	557 mm	573 mm	200 mm	14,2 Kg	96 Kg
360 L	1010 mm	1098 mm	880 mm	601 mm	580 mm	200 mm	20 Kg	160 Kg

- HDPE in an injection moulding process with UV treatment
- Manufactured using the injection moulding process
- Water, frost and heat resistant, also withstands many chemicals
- Sturdy galvanized steel wheel axle
- Rubber wheels Ø 200 mm, load capacity 100 kg / wheel
- Manufactured according to DIN 30740 / EN 840
- Pedal for 120 L only, optional
- Sack holder for 120 L cont. sold separately



Pedal as option

Right refracting profile	766941
Left refracting profile	766942

	120 L	240 L	360 L
Grey container	766610	766620	766630
Yellow container	766611	766621	766631
Blue container	766612	766622	766632
Green container	766613	766623	766633
Brown container	766614	766624	766634
White container	766615	766625	
Pedal on request	766900		
Sack holder	766910		

CONTIVIA 4

PLASTIC WASTE CONTAINER ON 4 WHEELS

660 L ▼

770 L ▼

1100 L ▼



Colors available:

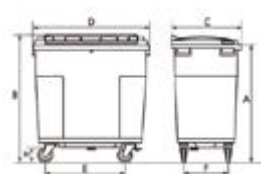

	A (mm)	B (mm)	C (mm)	D (mm)	E (mm)	F (mm)	WEIGHT (Kg)	MAX LOAD (Kg)
660 L	1130 mm	1215 mm	784 mm	1370 mm	880 mm	481 mm	45 Kg	270 Kg
770 L	1275 mm	1355 mm	784 mm	1370 mm	880 mm	608 mm	47 Kg	310 Kg
1100 L	1215 mm	1295 mm	1118 mm	1370 mm	850 mm	750 mm	58 Kg	450 Kg

- HDPE in an injection moulding process with UV treatment
- Manufactured using the injection moulding process
- Resistant to temperature changes, shocks, corrosion and chemicals
- Rubber wheels Ø 200 mm
- Heavy-duty rubber-tyred wheels, 2 with brake
- Corrosion-resistant galvanised metal parts
- Handles on 3 sides
- Manufactured according to DIN 30740 / EN 840
- To be emptied by tipping over a toothed rim as a standard feature



Soundproofed wheels

Right refracting profile	766941
Left refracting profile	766942

	660 L	770 L	1100 L
Grey container	766640	766650	766660
Yellow container	766641	766651	766661
Blue container	766642	766652	766662
Green container	766643	766653	766663
Brown container	766644	766654	766664

CONTIVIA BASIC 2

PLASTIC WASTE CONTAINER ON 2 WHEELS

120 L ▼



240 L ▼



360 L ▼



Colors available:

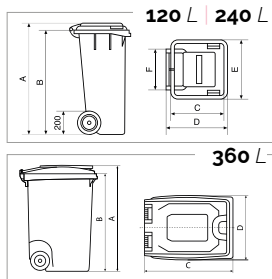

	A (mm)	B (mm)	C (mm)	D (mm)	E (mm)	F (mm)	WEIGHT (Kg)	MAX LOAD (Kg)
120 L	930 mm	875 mm	485 mm	550 mm	480 mm	355 mm	9 Kg	60 Kg
240 L	1070 mm	995 mm	655 mm	730 mm	580 mm	420 mm	13 Kg	116 Kg
360 L	1099 mm	1015 mm	880 mm	596 mm	-	-	15,5 Kg	160 Kg

- HDPE in an injection moulding process with UV treatment
- Water, frost and heat resistant, also withstands many chemicals
- Lid with book opening and anti-infiltration edge, seat for microchip housing
- Rubber wheels Ø 200 mm
- Manufactured according to DIN 30740 / EN 840
- Pedal + Sack holder for 120 L or 240 L, optional



Pedal as option



Sack holder

Right refracting profile	766941
Left refracting profile	766942

	120 L	240 L	360 L
Grey container	720010	720020	720030
Yellow container	720011	720021	720031
Blue container	720012	720022	720032
Green container	720013	720023	720033
Brown container	720014	720024	
White container	720015	720025	
Pedal + Sack holder on request	720001	720002	

CONTIVIA BASIC 4

PLASTIC WASTE CONTAINER ON 4 WHEELS

660 L ▼



770 L ▼



1100 L ▼



Colors available:



660 L | 770 L

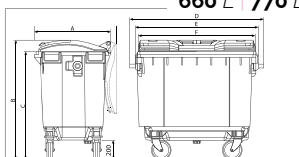

	A (mm)	B (mm)	C (mm)	D (mm)	E (mm)	F (mm)	WEIGHT (Kg)	MAX LOAD (Kg)
660 L	778 mm	1228 mm	1105 mm	1370 mm	1270 mm	1200 mm	40 Kg	310 Kg
770 L	778 mm	1365 mm	1243 mm	1370 mm	1270 mm	1200 mm	43 Kg	360 Kg
1100 L	1070 mm	1344 mm	1280 mm	1370 mm	1270 mm	1200 mm	50 Kg	510 Kg

1100 L

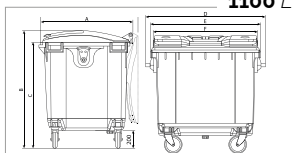

- HDPE in an injection moulding process with UV treatment
- Resistant to temperature changes, shocks, corrosion and chemicals
- Rubber wheels Ø 200 mm
- Heavy-duty rubber-tyred wheels, 2 with brake
- Flat lid with folding opening and lip handle
- Anti-seepage edge, seat for microchip housing
- Ergonomic handles for handling
- Cap on bottom for proper cleaning and sanitation
- Manufactured according to DIN 30740 / EN 840



Pedal kit as option

Right refracting profile **766941**

Left refracting profile **766942**

	660 L	770 L	1100 L
Grey container	720040	720050	720060
Yellow container	720041	720051	720061
Blue container	720042	720052	720062
Green container	720043	720053	720063
Pedal kit on request	720003	720004	720005

WASTE MANAGEMENT OUTDOOR AREAS



COMMON AREAS



FLORA

LITTER BIN

- Cold drawn iron plate with electrophoresis treatment
- Second layer of black powder epoxy coating for outdoor use
- Surrounding battens in polystyrene (UV and rot proof)
- Inner bucket in galvanized steel with lateral handles
- Perforated base to allow drainage of rainwater
- Vandal proof triangular keyed lock system
- Four ground fixing points



AVAILABLE IN AR ON MEDIAL APP 

40 L ▶



810 mm
410 mm
440 mm

60 L ▶



1060 mm
410 mm
440 mm

70 L ▶



850 mm
450 mm
450 mm

Cylindrical litter bin black steel-polystyrene 40 L **110506**

Cylindrical litter bin black steel-polystyrene 60 L **110501**

Square litter bin black steel-polystyrene 70 L **110516**



GRISÙ CITY

FIREPROOF ASHBIN



110 L ▶



1120 mm
490 mm



Ø 190 mm

- Powder epoxy coated galvanized steel body
- Galvanized inner bucket 110 L
- Self-extinguishing lid to prevent fire from spreading
- Ashtray fixed by a small chain
- Compulsory ground anchoring at 3 points



Ashtray
Ø 190 x h 55 mm



Ashbin base
Ø 200 mm

Fireproof ashbin 110 L

776001

DUBAI

ASHBIN



70 L ▶



900 mm
450 mm



Ø 190 mm

- Powder epoxy coated galvanized steel body
- AISI 430 brushed stainless steel lid
- Side opening lid with integrated ashtray
- 70 L inner bucket from galvanized steel
- Heavy base with three ground fixing points



AVAILABLE IN AR ON MEDIAL APP



Lid opening



Base

Ashbin 70 L

776002

GINEVRA

ASHBIN

- Steel body with electrophoresis treatment
- Powder epoxy coating for outdoor use
- Galvanized inner bucket with metal handle
- Ashtray and waste bin locked by the front door
- Rubber pads to ensure isolation from ground
- Two ground fixing points (fixing hardware included)



Opening system and internal bucket

Colors available:



Ashbin light grey - dark grey 48 L	103015
Ashbin manganese grey 48 L	103017
Ashbin light grey - dark grey 24 L	103010
Ashbin manganese grey 24 L	103018

GINEVRA MURALE

WALL MOUNTED ASHTRAY



Inner bucket

- Powder epoxy coated galvanized steel body
- Removable inner bucket (1.5 L) with metal handle
- Four mounting points (fixing kit included)



Colors available:



Wall mounted ashtray light grey - dark grey 1,5 L	103012
Wall mounted ashtray manganese grey 1,5 L	103014



VERONA MURALE

WALL MOUNTED ASHTRAY

1,5 L ▶
1000



Inner bucket 1,5 L



Supplied label

241 mm
81 mm
175 mm

- Galvanised sheet metal painted manganese grey (RAL7021)
- 3 mounting points (fixing kit included)
- Possibility of fixing in Verona or Amsterdam
- Adhesive label (cigarette symbol) supplied in packaging



Wall mounted ashtray black 1,5 L

789390

NIDO

WALL MOUNTED ASHTRAY

2 L ▶
1000



170 mm
155 mm
170 mm

0,5 L ▶
260



130 mm
93 mm
110 mm

Colors available:



- Brushed stainless steel or powder epoxy coated steel body
- Auto-extinguishing lid
- Easy to empty by tipping the ashtray up
- Wall mounted (screws included)



Wall mounted ashtray brushed s.steel 0,5 L

106001

Wall mounted ashtray dotted silver steel 0,5 L

106002

Wall mounted ashtray brushed s.steel 2 L

106003

Wall mounted ashtray dotted silver steel 2 L

106004

BIRKIN MURALE

WALL MOUNTED ASHTRAY

5 L ▶
3000



Ø 130 mm



Back hole for easy emptying

645 mm
180 mm

- Brushed stainless steel or powder epoxy coated steel body
- Stainless steel plate for putting cigarettes out
- Easy to empty by tipping the unit up
- Marked with cigarette symbol
- 3 wall fixing points (fixing hardware included)



Colors available:



Wall mounted ashtray black s.steel 5 L

108003

Wall mounted ashtray brushed s.steel 5 L

108004

BIRKIN EVO

FLOOR STANDING ASHTRAY



4,6 L ▶



2600

ø 129 mm



1120 mm

289 mm



Lock system



Opening



Bucket

- Black powder epoxy coated steel body
- Inner bucket with stainless steel handle
- Black powder epoxy coated steel body
- Inner bucket with stainless steel handle
- Plastic support feet
- 4 ground fixing points (hardware not included)



Floor standing ashtray black steel 4,6 L

108021

BIRKIN

FLOOR STANDING ASHTRAY

4 L

 2000

1000 mm

 290 mm



AVAILABLE IN AR ON MEDIAL APP



Lock system



Bucket



Weight base optional

Solid plastic ballast (Ø 360 mm - 7,3 kg) with polished stainless steel cover helps keep the ashtray stable in any situation, without fixing it to the ground.

- Brushed s.steel or black powder epoxy coated steel body
- Removable inner bucket with handle (4 L)
- Marked with cigarette symbol
- Rubber pads to ensure isolation from ground
- 4 ground fixing points (hardware not included)



Colors available:



Shaped floor standing ashtray black steel 4 L **108006**

Shaped floor standing ashtray brushed s.steel 4 L **108007**

Floor standing ashtray brushed s.steel 4 L **108009**

Weight base Ø 360 mm **103308**

SIRIO

LITTER BIN

30 L ▶



1040 mm
470 mm
330 mm



- Polished stainless steel body
- Stainless steel base
- 30 L bucket (Ø 300 mm - h 390 mm)
- Easy to empty by tipping the unit up
- Perforated base to allow drainage of rainwater
- Three ground fixing points required



Litter bin polished s.steel 30 L

106061

LEM

LITTER BIN

30 L ▶



1150 mm
350 mm
575 mm



Emptying system

- High-quality polished s.steel for outdoor use
- Galvanized inner bucket (30 L)
- Easy to empty by tipping the unit up
- Perforated base to allow drainage of rainwater
- Four ground fixing points required



Litter bin polished s.steel 30 L

106062

POLIS

LITTER BIN

Post for ground fixing

35 L ▶



460 mm
340 mm

1200 mm
30 mm
55 mm



- Galvanized steel body
- Finished with polyester or transparent protective varnish
- Easy to empty by tipping the unit up
- Bag held in place by stretch band
- Wall or pole mounting



Colors available:



Litter bin zinc plated steel with transparent varnish 35 L **778030**

Litter bin manganese grey coated zinc plated steel 35 L **778036**

Litter bin green coated zinc plated steel 35 L **778037**

Zinc plated post **778031**



MILUNA



LITTER BIN



- Polyester powder coated galvanized steel
- Perforated base to allow drainage of rainwater
- Bag held in place by stretch band
- Wall or pole mounting



Litter bin manganese grey 20 L	778051
Litter bin manganese grey 40 L	778061
Manganese grey post	778011

PIVO



LITTER BIN

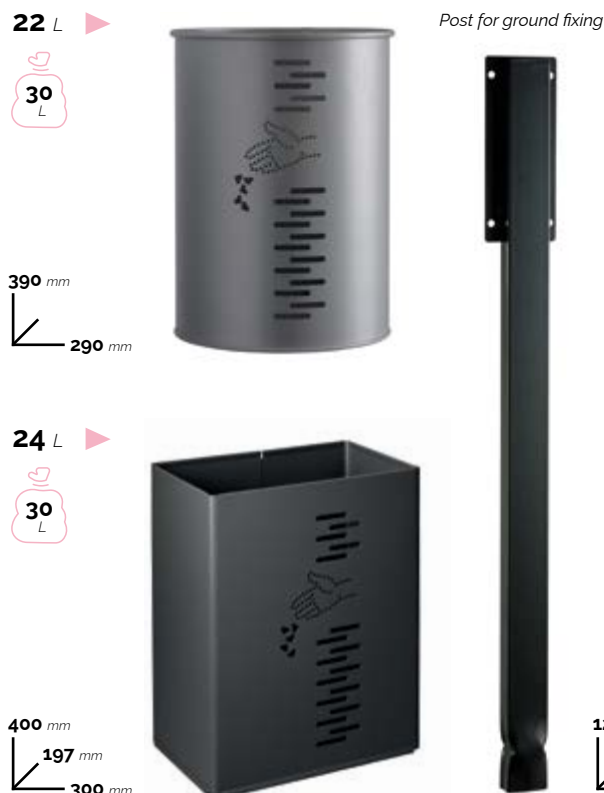

- Polyester powder coated galvanized steel
- Easy to empty by tipping the unit up
- Perforated base to allow drainage of rainwater
- Wall or pole mounting
- Bag held in place by stretch band



Nido ashtray holder
(page 115)



Easy to empty by tipping the bucket up



Wall mounting bracket
for rectangular bins



Colors available:



	MANGANESE GREY	GREEN	AISI 304 S.STEEL
Cylindrical litter bin 22 L	778001	778002	
Rectangular litter bin 24 L	778021		
Litter bin post	778011		
Wall-mounted bracket for rectangular version	778025		
Nido ashtray holder			778026

SNUPY

DOG WASTE BAGS DISPENSERS



400 mm
65 mm
270 mm

Colors available:



Bracket for post Ø 60 mm



- Stainless steel or hot-dip galvanized steel; brushed or epoxy coated finish
- Bags are dispensed through frontal hole; capacity: 600 bags max
- Triangular key lock for added security
- 2 brackets from s.steel AISI 304 for post mounting Ø 60 mm (sold separately)
- Post (Ø 60 mm - H 230 cm) + info board sold separately



	GREEN	BRUSHED S.STEEL	AISI 304 S.STEEL
Dog waste bag dispenser	103071	103070	
Two brackets for post mounting Ø 60 mm			103077
Green coated post h 230 cm	103076		
Info board	103078		

DOG WASTE BAGS



Opening

- High-density polyethylene
- 100 bags per bundle
- 10 bundles per carton (1000 pcs tot)

HDPE Dog waste bags

103075

CLASSIC

LITTER BIN

50 L ▶



790 mm
248 mm
440 mm

Post for ground fixing



- Polypropylene (PP)
- Resistant to UV, cold, heat and chemicals
- Stainless steel plate to put cigarettes out
- Perforated base to allow drainage of rainwater
- Vandal proof triangular keyed lock system and wall-mount fixing in 4 points included
- Post in zinc plated steel sold separately (Ø 60 mm - H 1200 mm)



• Easy to empty and clean



1200 mm
60 mm

Colors available:



Litter bin green polypropylene 50 L

102050

Litter bin grey polypropylene 50 L

102051

Zinc plated steel post

778016



HYGIENE

HYGIENE FOR MEDIAL IS THE IMPLEMENTATION OF INDIVIDUAL AND COLLECTIVE MEASURES TO SAFEGUARD THE MAINTENANCE OF CLEANLINESS IN LIVING AND WORKING ENVIRONMENTS.

The key aspects that form the basis of hygiene in our industry are the cleaning and disinfection of surfaces, the management of waste and unwanted and pollutant substances, the control of insect infestations, the maintenance and care of personal and environmental equipment.

MEDIAL **offers solutions that support people in the cleaning, management, control and maintenance of hygienic common spaces** (bathrooms, hotels, offices, etc.).

Within this introductory hat, Medial identifies four leading sections that guide the choice of the right product according to different needs: **DISPENSERS and HOTEL ACCESSORIES, HAND DRYERS and HAIR DRYERS, PERSONAL CARE and ENVIRONMENTAL CARE.**







HYGIENE

DISPENSERS AND HOTEL ACCESSORIES P. 126

SUPERB 2.0 RANGE	P. 129
BRINOX RANGE	P. 132
PURA RANGE	P. 139
NOIR RANGE	P. 142
BASICA RANGE	P. 146
STILECO RANGE	P. 152
WAVE E WAVE² RANGE	P. 154
INDUSTRIAL ROLL DISPENSERS	P. 158
BATHROOM ACCESSORIES	P. 163

HAND & HAIR DRYERS P. 170

ELECTRIC HAND DRYERS	P. 172
ELECTRIC HAIR DRYERS	P. 190

PERSONAL CARE P. 198

PERSONAL PROTECTIVE EQUIPMENTS	P. 201
FIRST AID KITS	P. 206
CONSUMABLES	P. 209

ENVIRONMENTAL CARE P. 212

AIR FRESHENERS	P. 216
ENVIRONMENTAL HYGIENE	P. 225
FLYING INSECT KILLERS	P. 230
KNIFE STERILIZER	P. 235
SANITIZING STATIONS	P. 236

HYGIENE

DISPENSER AND HOTEL ACCESSORIES







SUPERB 2.0

THE EVOLUTION OF THE SUPERB RANGE WITH ANTI-FINGERPRINT TREATMENT

State-of-the-art dispensers, rich in technical details and functional solutions for an innovative style that originates from the skillful material **fusion of stainless steel and thermoplastics**. Solid profiles designed to last over time. Soft and enveloping shapes that characterize the design, taking into account taste and contemporaneity of modern bathrooms. Discover all the accessories and new solutions of **SUPERB 2.0** range of bathroom accessories.



SUPERB 2.0



SUPERB 2.0

PAPER TOWEL DISPENSER (400 SHEETS/ C, Z OR V FOLDED)

- ABS backing and AISI 304 brushed s.steel with **anti-fingerprint treatment**
- Optimized release of paper
- Removable adapter for all paper types



AVAILABLE IN AR ON MEDIAL APP 

400 F ▶

 C, Z, V



376 mm
 140 mm
 286 mm



Release of paper



Adapter

Hand towel dispenser 400 sheets (c.z. v-folded)

105865

SUPERB 2.0

LIQUID/FOAM SOAP DISPENSERS

- ABS backing and AISI 304 brushed s.steel with **anti-fingerprint treatment**
- Refillable plastic tank 1 L with removable lid for easy filling
- Suitable for foam or liquid soaps (no microbeads)
- PUSH dispensing system



AVAILABLE IN AR ON MEDIAL APP 

1 L ▶



260 mm
 95 mm
 118 mm



Dispensing point



Refillable tank with removable lid

Liquid soap dispenser 1 L

105880

Foam soap dispenser 1 L

105885

COMPLETE THE RANGE WITH:

MILUNA

WALL MOUNTED WASTE BIN

20 L ▶ Ref. 773036

40 L ▶ Ref. 773046

Page 38

20 L ▶



40 L ▶



SUPERB 2.0

TOILET ROLL PAPER DISPENSER (400 M)

- ABS backing and AISI 304 brushed s.steel with **anti-fingerprint treatment**
- Holds up to 400 m toilet paper roll (max. Ø 290 mm)
- Plastic mandrin with Ø 32 mm with brake
- Adapter for mandrin with Ø 70 mm
- Three blades for easy paper cut



400 M ▶



329 mm
133 mm
265 mm

AVAILABLE IN AR ON MEDIAL APP



Spindle with brake



Three blades paper cut

Maxi jumbo toilet roll dispenser 400 m

105855

SUPERB 2.0

INTERFOLD TOILET TISSUE DISPENSER

- ABS backing and AISI 304 brushed s.steel with **anti-fingerprint treatment**
- Ergonomic dispensing ABS slot
- Optimized and hygienic release of paper



500 F ▶



227 mm
135 mm
146 mm

AVAILABLE IN AR ON MEDIAL APP



Release of paper



Interfold toilet tissue

Interfold toilet tissue dispenser 500 sheets

105870



BRINOX AND PURA RANGES

Clear surfaces, intriguing angles, cut-out details. **Brinox** and **Pura** synthesize respectively **precision, quality, and unfaltering passion** for stainless steel and white powder epoxy coated steel. A comprehensive range of bathroom accessories inspired by the minimalism of modern design, in which strength, **functionality and elegance** come together to meet the expectation of our most demanding customers.



BRINOX



BRINOX

HAND TOWEL DISPENSER (200-400 SHEETS C, Z FOLDED | 500 SHEETS C, Z, V FOLDED)

- AISI 430 polished s.steel or AISI 304 s.steel, with polished or brushed finish
- Holds C, Z-fold paper towel - 200, 400 sheets
- Holds C, Z or V-fold paper towel - 500 sheets



500 F ▶



400 mm
125 mm
280 mm



400 F ▶



350 mm
102 mm
280 mm



200 F ▶



250 mm
102 mm
280 mm



AISI 430 polished s. steel hand towel dispenser

AISI 304 polished s. steel hand towel dispenser

AISI 304 brushed s. steel hand towel dispenser

	200 F	400 F	500 F
AISI 430 polished s. steel hand towel dispenser	105011	105016	
AISI 304 polished s. steel hand towel dispenser	105012	105017	105015
AISI 304 brushed s. steel hand towel dispenser	105013	105019	

BRINOX SENSOR

AUTOMATIC DISPENSERS FOR LIQUID SOAP/GEL, FOAM, HYDRO-ALCOHOLIC CLEANER

- AISI 304 stainless steel, with polished or brushed finish
- Refillable plastic tank 1 L
- Suitable for liquid soap (no microbeads) or hydro-alcoholic gel
- Suitable for foam soap (mixture of 65% water and 35% non-creamy soap)
- Suitable for hydro-alcoholic liquid
- Infrared sensor operated
- Operates on four 1,5 V "AA" cell batteries (not included)
- AC adapter 110-240 V / 6 V (not included)
- **To be installed at least 30 cm from the sink**



1 L ▶

Liquid soap / hydro-alcoholic gel

Foam soap

Hydro-alcoholic liquid spray

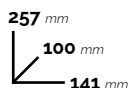

AC adapter

104950

Automatic dispensers for Liquid soap / Hand hydro-alcoholic gel

Automatic dispensers for Foam soap

Automatic dispensers for Hydro-alcoholic spray

**AISI 304 S.STEEL
POLISHED**

**AISI 304 S.STEEL
BRUSHED**

104530

104531

104532

104533

104534

104535

BRINOX

LIQUID SOAP DISPENSER

0,5 L ▶

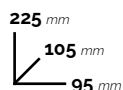

← Pull-operated

- AISI 304 stainless steel, with polished or brushed finish
- Refillable plastic tank 0,5 L
- For all kind of liquid soaps, except for microbead soaps
- Pull-operated anti-drip pump



AISI 304 polished s.steel Liquid soap dispenser

104036

AISI 304 brushed s.steel Liquid soap dispenser

104037

BRINOX

LIQUID SOAP DISPENSER

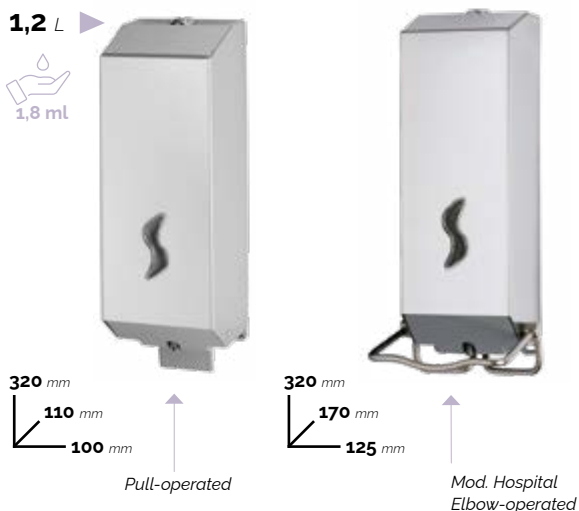

- AISI 304 stainless steel, with polished or brushed finish
- Refillable plastic tank 1,2 L
- For all kind of liquid soaps, except for microbead soaps
- Pull or elbow-operated (hospital) anti-drip pump



AISI 304 polished s.steel - PULL operated	105036
AISI 304 brushed s.steel - PULL operated	105037
AISI 304 polished s.steel - Mod. Hospital	105038
AISI 304 brushed s.steel - Mod. Hospital	105039

BRINOX

FOAM SOAP DISPENSER

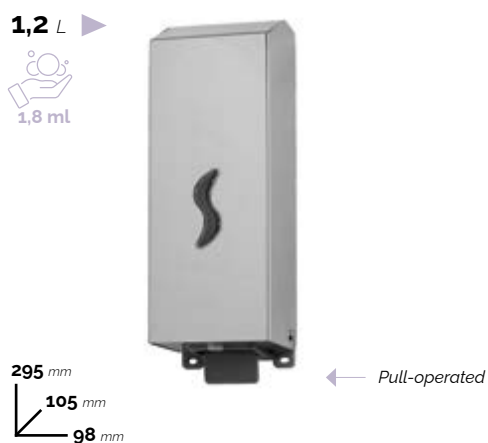

- AISI 304 stainless steel, with polished or brushed finish
- Refillable plastic tank 1,2 L for foam soap
- Pull-operated anti-drip pump



Foam soap dispenser AISI 304 polished s. steel	104030
Foam soap dispenser AISI 304 brushed s. steel	104031

BRINOX

LIQUID SOAP DISPENSER

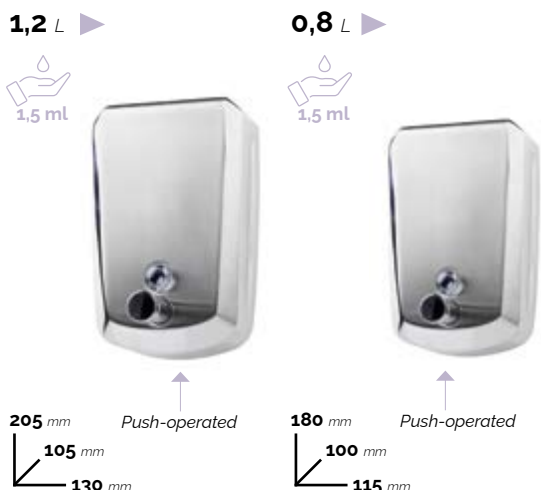

- AISI 304 stainless steel, with brushed cover and polished sides
- Refillable tank 0,8 L or 1,2 L
- For all kind of liquid soaps, except for microbead soaps
- Push-operated anti-drip pump



Liquid soap dispenser AISI 304 s. steel - 0,8 L	105031
Liquid soap dispenser AISI 304 s. steel - 1,2 L	105032

BRINOX

MINI AND MAXI JUMBO TOILET ROLL DISPENSER (200 M / 400 M)

- AISI 430 polished s.steel or AISI 304 s.steel, with polished or brushed finish
- Holds 200 mt toilet paper roll (max. 230 mm Ø)
- Rectangular spindle designed to minimize paper wastage
- Spindle diagonal: 55 mm
- Three blades for easy paper cut



200 M ▶



265 mm
127 mm
260 mm

400 M ▶



320 mm
130 mm
310 mm



Spindle



Three blades

	200 M	400 M
AISI 430 polished s.steel toilet roll dispenser	105001	105006
AISI 304 polished s.steel toilet roll dispenser	105002	105007
AISI 304 brushed s.steel toilet roll dispenser	105003	105009

BRINOX

INTERFOLD TOILET TISSUE DISPENSER (250 / 500 SHEETS)

- AISI 430 polished s.steel or AISI 304 s.steel, with polished or brushed finish
- Holds interfold toilet tissues
- Capacity: 250 sheets - SINGLE, 500 sheets - DOUBLE



250 F ▶



150 mm
120 mm
133 mm

500 F ▶



270 mm
120 mm
133 mm

	250 F	500 F
AISI 430 polished s.steel interfold toilet tissue dispenser	105024	105029
AISI 304 polished s.steel interfold toilet tissue dispenser	105021	105026
AISI 304 brushed s.steel interfold toilet tissue dispenser	105023	105028

BRINOX

TOILET BRUSH HOLDER



- AISI 304 s.steel with polished or brushed finish
- Inner plastic tank for liquid collection
- Freestanding or wall-mounted

AISI 304 Polished s.steel brush holder	130820
AISI 304 Brushed s.steel brush holder	130821
AISI 304 Polished s.steel Wall mounted brush holder	130822
AISI 304 Brushed s.steel Wall mounted brush holder	130823

TOP

TOILET BRUSH HOLDER



- AISI 304 s.steel with polished or brushed finish
- Inner plastic tank for liquid collection
- Plastic base

AISI 304 Polished s.steel brush holder	101811
AISI 304 Brushed s.steel brush holder	101812

BASIC METAL MURAL

WALL-MOUNTED TOILET BRUSH HOLDER



- S.steel, polished or brushed finish
- Inner plastic tank for liquid collection
- Wall mount bracket with 2 fixing points

Polished s.steel brush holder	101802
Brushed s.steel brush holder	101807

BASIC METAL

TOILET BRUSH HOLDER



- S.steel, polished or brushed finish
- Inner plastic tank for liquid collection

Polished s.steel brush holder	101800
Brushed s.steel brush holder	101805

COMPLETE THE RANGE WITH A LINE OF BATHROOM ACCESSORIES:

KATY

Page. 164-165

BRINOX

PLASTIC SANITARY TOWEL BAG DISPENSER



137 mm
25 mm
98 mm

- AISI 304 s. steel, with polished or brushed finish
- Wall mounted fastening or freestanding
- For HDPE sanitary bags (cod. 799002)



AISI 304 polished s.steel Sanitary towel bag dispenser **130006**

AISI 304 brushed s.steel Sanitary towel bag dispenser **130007**

PAPER SANITARY TOWEL BAG DISPENSER



280 mm
40 mm
130 mm

- AISI 304 s. steel, with polished or brushed finish
- For paper sanitary bags (14x28 cm - cod. 99096)



AISI 304 polished s.steel Sanitary towel bag dispenser **105053**

AISI 304 brushed s.steel Sanitary towel bag dispenser **105055**

TOILET SEAT COVER DISPENSER



316 mm
47 mm
215 mm

- AISI 304 stainless steel, with polished or brushed finish
- Vandal-proof stainless steel keyed lock
- For paper toilet seat covers (cod. 109114 -109118)



AISI 304 polished s.steel Toilet seat cover dispenser **105050**

AISI 304 brushed s.steel Toilet seat cover dispenser **105052**

SQUARE TISSUE HOLDER



126 mm
126 mm
126 mm

- AISI 304 s.steel, with polished or brushed finish
- Max box. dim (LxDxH): 12x12x12 cm
- Freestanding or wall mounted installation



AISI 304 polished s.steel tissue holder **105057**

AISI 304 brushed s.steel tissue holder **105058**

TISSUE AND/OR GLOVES HOLDER



75 mm
137 mm
260 mm

- S.steel AISI 430, with polished or brushed finish
- Max box. dim (LxDxH): 25x13x7 cm
- Wall mounted fastening or freestanding
- Rubber protection on the base



AISI 430 polished s.steel tissue holder **105051**

AISI 430 brushed s.steel tissue hold **105056**

AISI 430 polished s.steel tissue/glove holder **105054**

COMPLETE THE RANGE WITH:

BRINOX

SANITARY TOWEL DISPOSAL BIN

AISI 304 brushed s.steel
30 L ▶ Ref. 789080

Page 36

30 L ▶



COMPLETE THE RANGE WITH:

BRINOX

PUSH OPENING WASTE BIN

AISI 304 polished s.steel
25 L ▶ Ref. 110520
AISI 304 brushed s.steel
25 L ▶ Ref. 110521

Page 36

25 L ▶



COMPLETE THE RANGE WITH:

STORICO

PUSH WASTE BINS

Polished s.steel
50 L ▶ Ref. 790557

Page 80

50 L ▶



COMPLETE THE RANGE WITH:

STORICO

SWING WASTE BINS

Polished s.steel
50 L ▶ Ref. 790563

Page 81

50 L ▶



COMPLETE THE RANGE WITH:

BOB

WASTE BIN

Polished s.steel
25 L ▶ Ref. 773001
Brushed s.steel
25 L ▶ Ref. 773006

Page 37

25 L ▶



COMPLETE THE RANGE WITH:

BOB BASIC

WASTE BIN

Polished s.steel
25 L ▶ Ref. 773002
Brushed s.steel
25 L ▶ Ref. 773007

Page 37

25 L ▶



COMPLETE THE RANGE WITH:

BRINOX

WALL-MOUNTED WASTE BIN

AISI 304 polished s.steel
10 L ▶ Ref. 105062
AISI 304 brushed s.steel
10 L ▶ Ref. 105063

Page 37

10 L ▶



COMPLETE THE RANGE WITH:

BIN PLUS

PEDAL BIN

Polished s.steel
5 L ▶ Ref. 112055
Brushed s.steel
5 L ▶ Ref. 112059

Page 39

5 L ▶



PURA



PURA

HAND TOWEL DISPENSER (400 SHEETS C, Z FOLDED)

400 F ▶



350 mm
102 mm
280 mm



- White powder epoxy coated steel
- Holds C, Z-fold paper towel - 400 sheets



Hand towel dispenser white steel 400 S

105018

PURA

LIQUID SOAP DISPENSER

1,2 L ▶



← Pull-operated

320 mm
110 mm
100 mm

- White powder epoxy coated steel
- Refillable plastic tank 1.2 L
- For all kind of liquid soaps, except for microbead soaps
- Pull anti-drip pump



Liquid soap dispenser white steel 1.2 L

105035

PURA

MAXI JUMBO TOILET ROLL DISPENSER (400 M)

400 M ▶



320 mm
130 mm
310 mm



Spindle



Three blades



"Essential" version

- White powder epoxy coated steel
- Holds up to 400 m toilet paper roll (max. Ø 300 mm)
- Rectangular spindle designed to minimize paper wastage
- Spindle diagonal: 55 mm
- Three blades for easy paper cut



Maxi jumbo toilet paper white steel 400 M

105008

Maxi jumbo toilet paper white 400 M (Essential)

105608

PURA

INTERFOLD TOILET TISSUE DISPENSER (500 SHEETS)

500 F



Double

270 mm
120 mm
133 mm



- White powder epoxy coated steel
- Holds interfold toilet tissues
- Capacity: 500 sheets



Interfold toilet tissue dispenser white steel

105027

PURA

TOILET BRUSH HOLDER



- White coated steel
- Inner plastic tank for liquid collection



380 mm
98 mm

Toilet brush holder white steel

101801

COMPLETE THE RANGE WITH:

PURA

WASTE BIN

10 L ▶ Ref. 105061

Page 37

10 L ▶



MILUNA

WASTE BIN

20 L ▶ Ref. 773033

40 L ▶ Ref. 773043

Page 38

20 L 40 L ▶





NOIR AND BASICA RANGES

Basica and Noir, two comprehensive ranges of washroom accessories, bring a simple but stylish design to any washroom without sacrificing functionality. This wide set of accessories are made from sturdy **Black or White ABS**. It excels in **quality, easy- of- use and simplicity**. All these features result in a professional washroom hardware, that goes beyond fashion trends and suite any bathroom decor. Noir and Basica are also expression of **maximum design flexibility**. In fact, our ranges offer a choice of over 30 products from which you can choose the solution that best meets the needs of the room to be set up.



NOIR



NOIR

HAND TOWEL DISPENSER (400 SHEETS C, Z, M FOLDED | 500 SHEETS C, Z, M, V FOLDED)

- Silver ABS backing and black ABS cover
- Holds C, Z or M-fold paper towel - 400 sheets
- Holds C, Z, M or V-fold paper towel - 500 sheets



AVAILABLE IN AR ON MEDIAL APP 

500 F ▶



380 mm
128 mm
278 mm

400 F ▶



340 mm
92 mm
250 mm



Hand towel dispenser black ABS

400 F	500 F
104220	104226

NOIR

LIQUID OR FOAM SOAP DISPENSER

- Silver ABS backing and black ABS cover
- Refillable plastic tank 0,5 L or 1 L
- For all kind of liquid soaps, except for microbead soaps (Ref. 104240, 104241)
- For foam soaps (Ref. 104245)
- Push-operated anti-drip pump



1 L ▶



275 mm
105 mm
110 mm

0,5 L ▶



209 mm
93 mm
101 mm

0,75 L ▶



210 mm
98 mm
114 mm

AVAILABLE IN AR ON MEDIAL APP



Push-operated

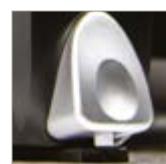

Viewing window

Liquid soap dispenser black ABS 0,5 L	104240
Liquid soap dispenser black ABS 1 L	104241
Foam soap dispenser black ABS 0,75 L	104245

NOIR

MINI AND MAXI JUMBO TOILET ROLL DISPENSER (200 M / 400 M)

- Silver ABS backing and black ABS cover
- Mini jumbo: spindle Ø 45 mm for 200 M paper roll (max. dim. Ø 255 mm)
- Maxi jumbo: spindle Ø 45 and 70 mm for 400 M paper roll (max. dim. Ø 300 mm)



AVAILABLE IN AR ON MEDIAL APP



MINI JUMBO

200 M ▶



294 mm
120 mm
282 mm

MAXI JUMBO

400 M ▶



355 mm
137 mm
347 mm

Mini jumbo toilet paper disp. black ABS 200 M	104201
Maxi jumbo toilet paper disp. black ABS 400 M	104205

NOIR

INTERFOLD TOILET TISSUE DISPENSER (250 / 500 SHEETS)

- Silver ABS backing and black ABS cover
- Holds 250 sheets (or 1 stand. roll) or 500 interfolded sheets (or 2 stand. rolls)
- It can also hold household rolls



AVAILABLE IN AR ON MEDIAL APP 

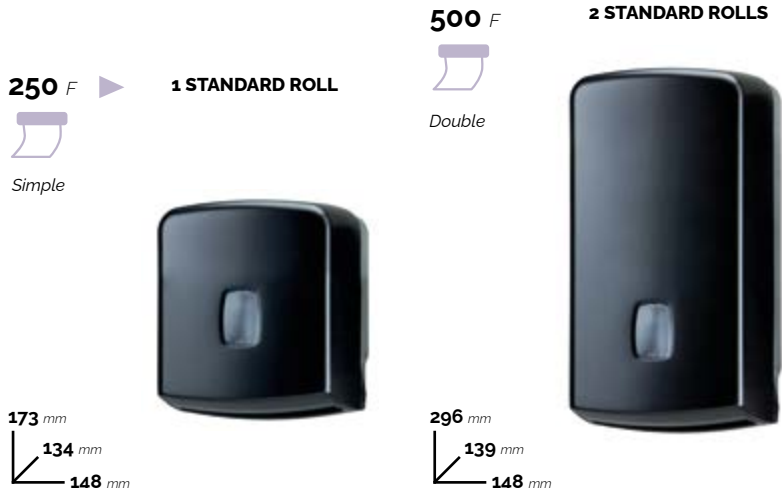

- Interfold toilet tissue dispenser black ABS 500 S or 2 rolls **104256**
- Interfold toilet tissue dispenser black ABS 250 S or 1 roll **104257**

NOIR

SQUARE TISSUES DISPENSER

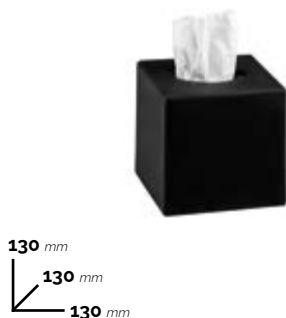

NOIR

RECTANGULAR TISSUE DISPENSER

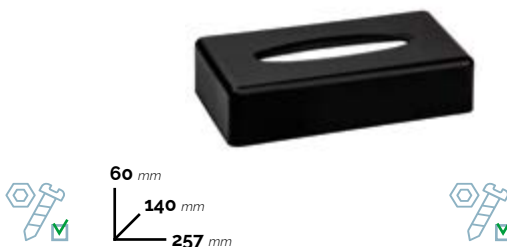

NOIR

TOILET BRUSH HOLDER



- Black ABS backing and cover
- Holds box dim. 11,5x11,5x12 cm
- Freestanding or wall mounted

- Black ABS backing and cover
- Holds box dim. 24,5x13,5x5,5 cm
- Wall mounted or freestanding

- Silver ABS handle and black ABS base
- Freestanding or wall mounted

Tissue holder black ABS **130020**

Tissue holder black ABS **130005**

Wall mounted Black ABS **104280**

Freestanding Black ABS **104282**

NOIR

PLASTIC SANITARY DISPOSAL BAG DISPENSER

137 mm
25 mm
98 mm



- Black ABS backing and cover
- For HDPE sanitary bags dim. (LxDxH): 8,7x2x12,4 cm
- Suitable for refills ref. 799002
- Wall mounted or freestanding



Plastic sanitary disposal bags disp. black ABS

130004

PAPER SANITARY DISPOSAL BAG DISPENSER

290 mm
54 mm
140 mm



- Black ABS backing and cover
- For paper sanitary bags dim. (LxH): 12x28 cm (cod. 99096)



Paper sanitary disposal bag disp. silver ABS

130017

TOILET SEAT COVER DISPENSER

290 mm
57 mm
235 mm



- Black ABS backing and cover
- Suitable for toilet seat cover ref. 109114 or 109118
- Max box. dim (LxDxH): 19,5x4x25 cm



Toilet seat cover dispenser black ABS

130014

COMPLETE THE RANGE WITH:

NOIR

SANITARY TOWEL DISPOSAL BIN



15 L ▶ Ref. 104281

Page 41

MILUNA NOIR

WALL MOUNTED WASTE BIN

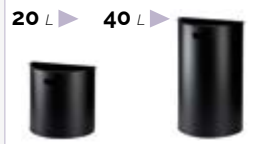

20 L ▶ Ref. 773031
40 L ▶ Ref. 773041

Page 38

AMÉLIE

AUTOMATIC MURAL TRASH CAN



12 L ▶ Ref. 111211

Page 42

AMÉLIE

MURAL TRASH CAN



12 L ▶ Ref. 111201
32 L ▶ Ref. 111221

Page 43

NEW BIN BASIC

PEDAL BIN



5 L ▶ Ref. 913052

Page 40

ESA

PEDAL BIN



5 L ▶ Ref. 909106

Page 45

RIF BASIC

SWING PAPER BIN



35 L ▶ Ref. 909536

Page 44

SLIM

PEDAL WASTE BIN



10 L ▶ Ref. 909811

Page 72

BASICA



BASICA

HAND TOWEL DISPENSER (200-400 SHEETS C, Z, M FOLDED | 500 SHEETS C, Z, M, V FOLDED)

- Grey ABS backing and white ABS cover
- Holds C, Z or M-fold paper towel - 400 sheets
- Holds C, Z, M or V-fold paper towel - 500 sheets



AVAILABLE IN AR ON MEDIAL APP 

500 F 

 C, Z,
 M, V



400 F 

 C, Z, M



200 F 

 C, Z, M



Opening

Hand towel dispenser white ABS

200 F	400 F	500 F
104022	104020	104026

BASICA

LIQUID SOAP DISPENSER

- Grey ABS backing and white ABS cover
- Refillable plastic tank 0,5 L or 1 L
- For all kind of liquid soaps, except for microbead soaps

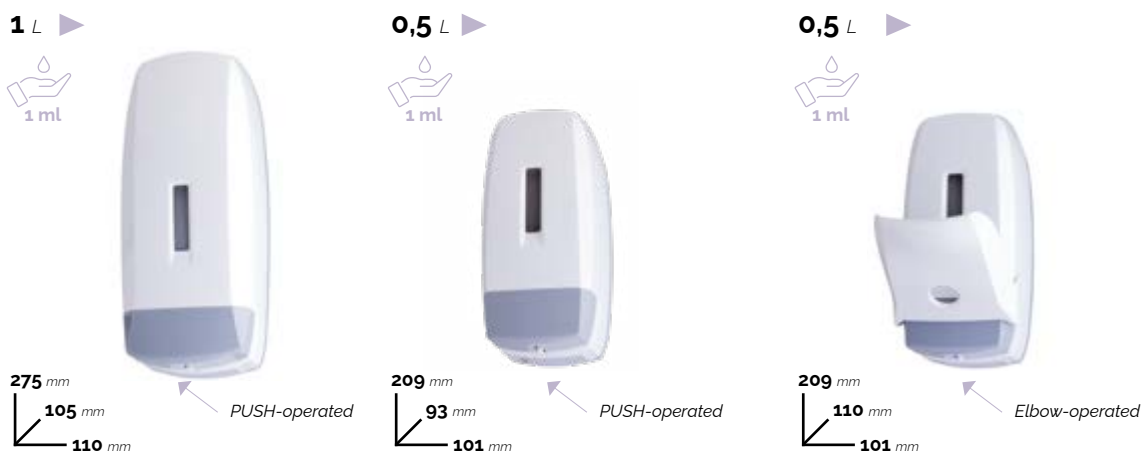

Liquid soap dispenser white ABS 0,5 L	104040
Liquid soap dispenser white ABS 1	104041
Elbow-oper. liquid soap dispenser white ABS 0,5 L	104046

BASICA

FOAM SOAP DISPENSER

- Backing and cover from silver coated ABS
- Refillable plastic tank 0,5 and 0,75 L
- For foam soaps
- Push-operated anti-drip pump
- Plastic key locked system on cod. 104045
- Cover opening with push button on cod. 104044

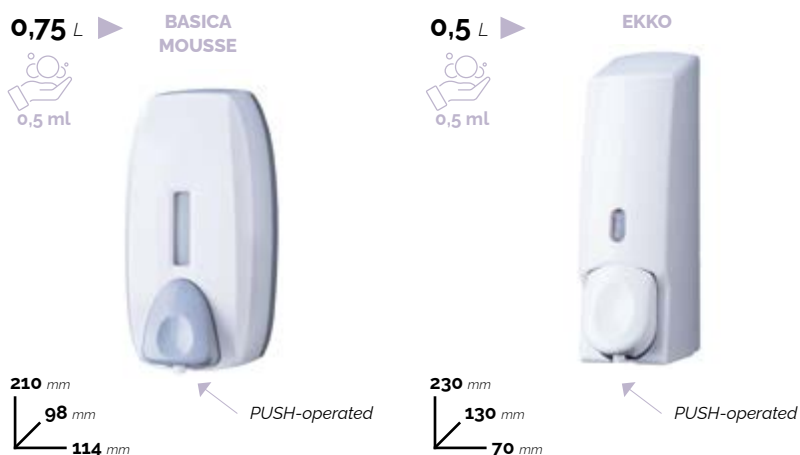

Foam soap dispenser Ekko 0,5 L	104044
Foam soap dispenser Basica Mousse 0,75 L	104045

BASICA

AUTOMATIC DISPENSERS FOR LIQUID SOAP/GEL, FOAM

- Grey ABS backing and white ABS cover
- Refillable plastic tank 0,5 L or 1 L
- Liquid soap (no microbeads) or hydro-alcoholic version / Foam soap version
- Infrared sensor operated
- Battery powered - 4x1,5 V alkaline AA (not included)
- AC adapter for 1 L dispenser only (not included)
- **Installation at least 30 cm from the sink**

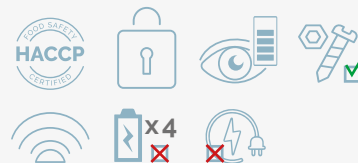

AC adapter

104951

Automatic liquid soap / hand gel disp. white ABS 1 L **104050**

Automatic liquid soap / hand gel disp. white ABS 0,5 L **104055**

Automatic foam soap white ABS 1 L **104051**

BASICA

AUTOMATIC OR PUSH HYDRO-ALCOHOLIC CLEANER DISPENSER

- Grey ABS backing and white ABS cover
- Refillable plastic tank 0,5 L ou 1 L
- For alcohol-based liquid cleaner
- Infrared sensor operated or PUSH Version
- Battery powered 3x1,5 V alkaline AA (not included)
- AC Adapter for **BASICA MATIC** (Ref. 104951)
- **Installation at least 30 cm from the sink**



BASICA MATIC

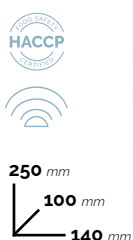

BASICA SPRAY SENSOR

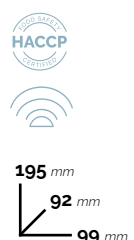

BASICA SPRAY

PUSH operated

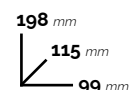

AC adapter Ref. 104951

Liquid hand hydro-alcoholic automatic dispenser white ABS 1 L **104052**

Liquid hand hydro-alcoholic automatic dispenser white ABS 0,5 L **104053**

Liquid hand hydro-alcoholic PUSH dispenser white ABS 0,5 L **104047**

BASICA

MINI AND MAXI JUMBO TOILET ROLL DISPENSER (200 M / 400 M)

200 M ▶



MINI JUMBO



400 M ▶



MAXI JUMBO



- Grey ABS backing and white ABS cover
- Mini jumbo: spindle Ø 45 mm for 200 m paper roll (max. Ø 255 mm)
- Maxi jumbo: spindle Ø 45 and 70 mm for 400 m paper roll (max. Ø 300 mm)



Mini jumbo toilet paper dispenser white ABS 200 M **104001**

Maxi jumbo toilet paper dispenser white ABS 400 M **104005**

BASICA

INTERFOLD TOILET TISSUE DISPENSER (250 / 500 SHEETS)

250 F ▶



1 STANDARD ROLL

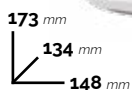

500 F ▶



2 STANDARD ROLLS

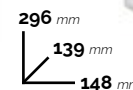

- Grey ABS backing and white ABS cover
- Holds 250 sheets (1 stand. roll) or 500 interfolded sheets (or 2 stand. rolls)
- It can also hold household rolls



Interfold toilet tissue dispenser white ABS 500 S or 2 rolls **104056**

Interfold toilet tissue dispenser white ABS 250 S or 1 roll **104057**

BASICA

SQUARE TISSUES DISPENSER

Colors available:

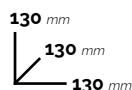

- White or chromed ABS
- Holds box dim. 11,5x11,5x12 cm
- Freestanding or wall mounted

Square tissue holder white ABS **130021**

Square tissue holder chromed ABS **130022**

BASICA

RECTANGULAR TISSUE DISPENSER

Colors available:



- ABS body, with white or chromed finish
- Holds box dim. 24,5x13,5x5,5 cm
- Wall mounted fastening or freestanding

Rectangular tissue holder white ABS **130000**

Rectangular tissue holder chromed ABS **130003**

BASICA

PLASTIC SANITARY TOWEL BAGS DISPENSERS



Colors available:



- White or chromed ABS
- For HDPE sanitary bags dim. (LxDxH)
- 8,7x2x12,4 cm (cod. 799002)
- Wall mounted fastening or freestanding



Plastic sanitary towel bag dispenser white ABS **130001**

Plastic sanitary towel bag dispenser chromed ABS **130002**

PAPER SANITARY TOWEL BAG DISPENSERS



- White ABS
- For paper sanitary bags dim. (LxH): 12x28 cm
- Compatible with refill cod. 99096



White paper sanitary towel bag dispenser **130015**

TOILET SEAT COVER DISPENSER



- White ABS
- Max box. dim (LxDxH): 19,5x4x25 cm
- Suitable for toilet seat cover ref. 109114 or 109118



White toilet seat cover dispenser **130010**

FREEST. / WALL-MOUNTED TOILET BRUSH HOLDER



- White or Silver ABS handle and structure;
- White bristle tuft
- Freestanding or wall mounted fastening



Wall-mounted bracket

Colors available:



Freestanding toilet brush holder white ABS **104100**

Wall mounted toilet brush holder white ABS **104102**

Freestanding toilet brush holder silver ABS **104480**

Wall-mounted toilet brush holder silver ABS **104482**

COMPLETE THE RANGE WITH:

BASICA LADY BIN

SANITARY TOWEL DISPOSAL BINS:



15 L



17 L

BASICA 15 L ▶ Ref. 104081
LADY BIN 17 L ▶ Ref. 705081

Page 41

RIF BASIC

WASTE BIN WITH SLOT LID



10 L

18 L

10 L ▶ Ref. 909010
18 L ▶ Ref. 909018

Page 44

AMÉLIE

WASTE BIN



32 L

12 L

12 L

32 L ▶ Ref. 111223
12 L ▶ Ref. 111203 - 111213

Pages 42-43

ESA

PEDAL BIN

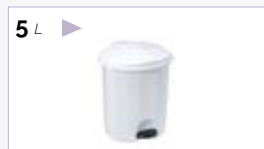

5 L

5 L ▶ Ref. 909105

Page 45



STILECO RANGE



Medial continues its quest for **sustainable solutions** that respect the environment and the needs of its customers, with the aim of **combining efficiency and aesthetics with sustainability**.

Stileco is our first line of dispensers made of 100% recycled plastic.

A range of dispensers with an **essential and versatile** character that expresses **personality**, embellished by the "green leaf" control display to once again underline the commitment to "Green".

Practicality and functionality complete the picture of a perfect range for those who want to improve the style of their environment while respecting our planet.

STILECO

HAND TOWEL DISPENSER (600 SHEETS - C, Z, M, V FOLDED)

600 F ▶



370 mm
130 mm
277 mm



- 100% recycled ABS base and cover
- Polycarbonate front viewing window
- Holds C, Z, M or V-fold paper towel - 600 sheets



AVAILABLE IN AR ON MEDIAL APP

WARNING: some recycled plastic products may have slight variations in colour shade

Hand towel dispenser 600 sheets (z-folded)

920020

STILECO

SOAP AND/OR GEL HYDRO-ALCOHOLIC DISPENSER

1 L ▶

0,7 L ▶

260 mm
95 mm
130 mm



210 mm
90 mm
128 mm



Push-Operated



Refillable tank

- 100% recycled ABS base and cover
- Polycarbonate front viewing window
- Refillable plastic tank 1 L or 0,7 L
- Suitable for soaps and hydroalcoholic gels



AVAILABLE IN AR ON MEDIAL APP

WARNING: some recycled plastic products may have slight variations in colour shade

Liquid soap dispenser white 1 L

920041

Liquid soap dispenser white 0,7 L

920040

STILECO

MINI AND MAXI JUMBO TOILET ROLL DISPENSER (200 M / 400 M)

MAXI JUMBO

MINI JUMBO

326 mm
125 mm
304 mm



272 mm
125 mm
253 mm



Release of Paper



Adapter

- 100% recycled ABS base and cover
- Polycarbonate front viewing window
- Max. MINI JUMBO roll diameter: Ø 245 mm
- Max. MAXI JUMBO roll diameter: Ø 275 mm
- Spindle Ø 45 to 60 mm max.



AVAILABLE IN AR ON MEDIAL APP

WARNING: some recycled plastic products may have slight variations in colour shade

Mini jumbo toilet paper dispenser

920001

Maxi jumbo toilet paper dispenser

920002

STILECO

INTERFOLD TOILET TISSUE DISPENSER (500 SHEETS)

500 F ▶



277 mm
135 mm
135 mm



Release of Paper

- 100% recycled ABS base and cover
- Polycarbonate front viewing window
- For interfold toilet tissues
- Holds 500 interfolded sheets



AVAILABLE IN AR ON MEDIAL APP

WARNING: some recycled plastic products may have slight variations in colour shade

Interfold toilet tissue dispenser 500 s

920005

STILECO

CENTER PULL TOWEL DISPENSERS

MAXI



325 mm
240 mm
240 mm

MINI



285 mm
150 mm
140 mm

- 100% recycled ABS base and cover
- Polycarbonate front viewing window
- Max. roll diameter vers. MAXI: Ø 230 mm
- Max. roll diameter vers. MINI: Ø 120 mm



AVAILABLE IN AR ON MEDIAL APP

WARNING: some recycled plastic products may have slight variations in colour shade

MAXI center pull dispenser

920031

MINI center pull dispenser

920030

STILECO

AUTOCUT TOWEL PAPER DISPENSER



382 mm
233 mm
280 mm



Release of Paper



Roll Holder

- 100% recycled ABS base and cover
- Works mechanically by tearing towel off
- Polycarbonate front viewing window
- Max. roll diameter: Ø 210 mm
- Max. roll width: 195-205 mm
- Sheet length: 270 mm



AVAILABLE IN AR ON MEDIAL APP

WARNING: some recycled plastic products may have slight variations in colour shade

Autocut paper towel dispenser

920050

WAVE



WAVE

HAND TOWEL DISPENSER (300 SHEETS C,Z | C, Z, M, V FOLDED)



- Grey ABS backing and white ABS cover
- Holds C and Z-fold paper towel version
- Holds C, Z, M, V-fold paper towel version
- Capacity up to 300 sheets



C or Z-fold white paper towel dispenser 300 sheets	908020
C, Z, M, V-fold white paper towel dispenser 300 sheets	908021

WAVE

LIQUID / FOAM SOAP DISPENSER

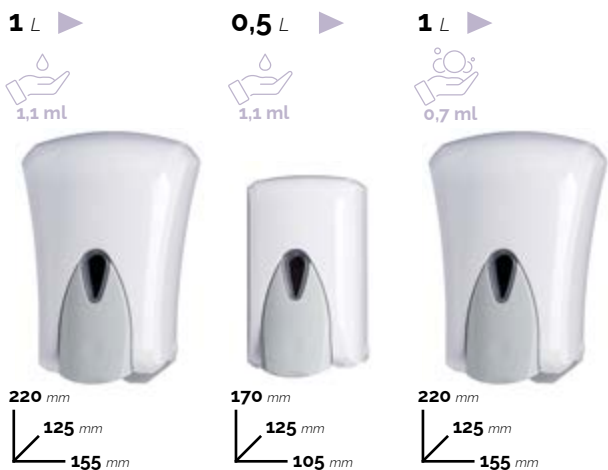

- Grey ABS backing and white ABS cover
- Refillable plastic tank 0,5 L or 1 L
- For all kind of liquid soaps (NO microbeads ones) or foam soaps
- Push-operated anti-drip pump



Liquid soap dispenser white ABS 0,5 L	908040
Liquid soap dispenser white ABS 1 L	908041
Foam soap dispenser white ABS 1 L	908045

WAVE

CENTRAL PULL-OUT TOILET PAPER DISPENSER

100 M ▶

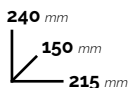

- Grey ABS backing and white ABS cover
- For toilet paper rolls thickness of 100–115 cm (and max roll Ø 160 mm)



Central pull-out toilet paper dispenser

908006

WAVE

MINI AND MAXI JUMBO TOILET ROLL DISPENSER (200 M / 400 M)

200 M ▶



MINI JUMBO

400 M ▶



MAXI JUMBO

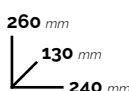

- Grey ABS backing and white ABS cover
- MINI JUMBO: spindle Ø 40 mm for 200 M paper roll (max. Ø 190 mm)
- MAXI JUMBO: spindle Ø 40 mm for 400 M paper roll (max. Ø 250 mm)
- Additional ring for spindle, with 55 mm diameter
- Three blades for easy paper cut



Maxi Jumbo toilet paper dispenser white ABS 200 M

908001

Maxi Jumbo toilet paper dispenser white ABS 400 M

908002

WAVE

INTERFOLD TOILET TISSUE DISPENSER (300 SHEETS)

300 F ▶

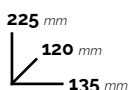

- Grey ABS backing and white ABS cover
- Capacity: 300 sheets



Interfold toilet paper disp. white ABS 300 sheets

908025

WAVE²



WAVE²

HAND TOWEL DISPENSER (C,Z | C, Z, M, V FOLDED)

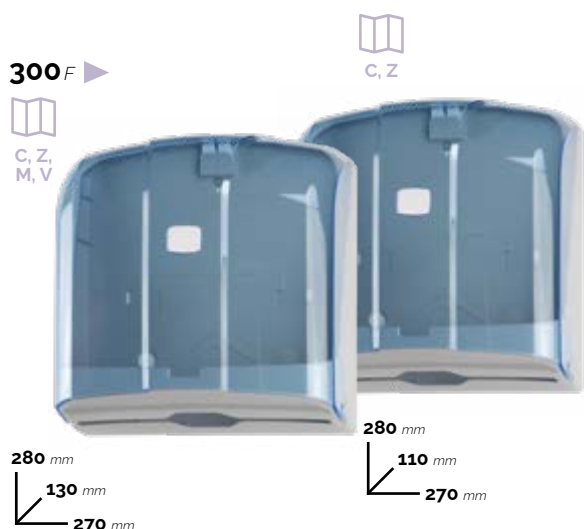

- Grey ABS backing and transparent blue SAN cover
- Holds C and Z-fold paper towel version
- Holds C, Z, M, V-fold paper towel version
- Capacity up to 300 sheets



C or Z-fold paper towel dispenser - 300 sheets	908120
C, Z, M, V-fold paper towel dispenser - 300 sheets	908121

WAVE²

LIQUID / FOAM SOAP DISPENSER

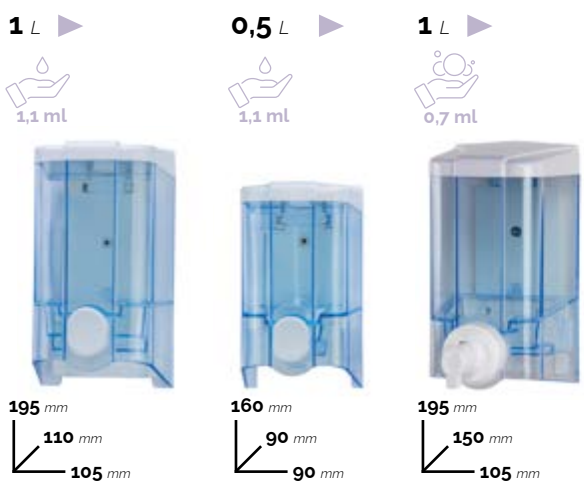

- Grey ABS backing and transparent blue SAN cover
- Refillable plastic tank 0,5 L or 1 L
- For all kind of liquid soaps (NO microbeads ones) or foam soaps
- Push-operated anti-drip pump



Liquid soap dispenser white ABS-transp. SAN 0,5 L	908140
Liquid soap dispenser white ABS-transp. SAN 1 L	908141
Foam soap dispenser white ABS-transp. SAN 1 L	908145

WAVE²

MINI AND MAXI JUMBO TOILET ROLL DISPENSER (200 M / 400 M)

200 M ▶



MINI JUMBO

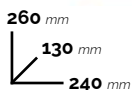

400 M ▶



MAXI JUMBO

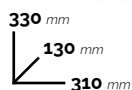

- Grey ABS backing and transparent blue SAN cover
- MINI JUMBO: spindle Ø 40 mm for 200 M paper roll (max. Ø 190 mm)
- MAXI JUMBO: spindle Ø 40 mm for 400 M paper roll (max. Ø 250 mm)
- Additional ring for spindle, with 55 mm diameter
- Three blades for easy paper cut



Mini jumbo toilet paper dispenser ABS 200 M **908101**

Maxi jumbo toilet paper dispenser 400 M **908102**

WAVE²

INTERFOLD TOILET TISSUE DISPENSER (300 SHEETS)

300 F ▶

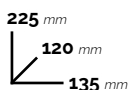

- Grey ABS backing and transparent blue SAN cover
- Capacity: 300 sheets



Interfold toilet paper dispenser 300 sheets **908125**

WAVE

CENTER PULL TOWEL PAPER DISPENSER

Colors available:

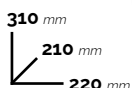

- Backing and shell made from ABS or ABS/SAN
- Holds unpre-cut center pull paper roll
- Max. roll dimension: Ø 190 mm x width 210 mm



Blue transparent center pull dispenser **908124**

White center pull dispenser **908024**

BRINOX SPIRAL

CENTER PULL TOWEL PAPER DISPENSER



370 mm
260 mm
270 mm

Colors available:



- Polished AISI 304 or brushed AISI 201 stainless steel
- Holds one non-perforated center-pull roll towel
- Max. roll dimension (ØxH): 250x280 mm
- Adapter for perforated paper roll on request (cod. 110594)



Center pull towel dispenser 304 polished s.steel	110524
Center pull towel dispenser 201 brushed s.steel	110525
Adapter for perforated paper	110594

BASICA

CENTER PULL TOWEL PAPER DISPENSER



356 mm
214 mm
240 mm

Colors available:

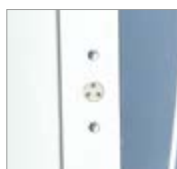

Side lock

- Grey ABS backing and blue transparent or white ABS cover
- Holds pre-cut center pull paper roll
- Max. roll dim.: Ø 200 mm - width 200 mm
- Side lock with plastic key



Blue transparent center pull dispenser	104024
White center pull dispenser	104025

ROLLOUT

CENTER PULL TOWEL PAPER DISPENSER



350 mm
345 mm
410 mm

- White ABS base and blue transparent ABS casing
- Max. roll dimensions: (Ø) 290 mm x (L) 290 mm
- Wall-mounted or on-table stand



Center pull towel dispenser blue transparent - white	705636
--	---------------

MAROLL VERTICALE

MAXI CENTER PULL TOWEL PAPER DISPENSER



340 mm
260 mm
260 mm

- White ABS base and transparent ABS fairing
- Suitable for center feed roll paper
- Max. roll dimensions: (Ø) 245 mm x (L) 265 mm



Maxi center towel dispenser white-blue transparent

700519

AUTOCUT

AUTOCUT TOWEL PAPER DISPENSER



370 mm
240 mm
350 mm

- White ABS backing and cover
- Works mechanically by tearing towel off
- For non-perforated roll towel
- Roll dim.: max. Ø 210 mm, max. width 210 mm
- Sheet length: 240 mm



Autocut paper towel dispenser

709054

MINI AUTOCUT

MINI AUTOCUT TOWEL PAPER DISPENSER



330 mm
204 mm
314 mm

- Transparent ABS backing and white ABS cover
- Works mechanically by tearing towel off
- For non-perforated roll towel
- Roll dim.: max. Ø 195 mm, max. width 210 mm
- Sheet length: 230 mm



Mini autocut paper towel dispenser

709052

ROLIND

INDUSTRIAL TOWEL ROLL HOLDER



ON STAND VERSION

Sack holder optional



- AISI 304 polished s.steel or powder epoxy coated steel
- Holds one roll having external Ø 350 mm
- Compatible with roll having an inner carton tube Ø 20 mm min.
- Roll holder bar 430 mm
- Plastic cones hold the roll securely in place (Ø min. 42 mm, Ø max. 55 mm)
- Sack holder optional, sold separately



ON STAND OR WALL-MOUNTED VERSION

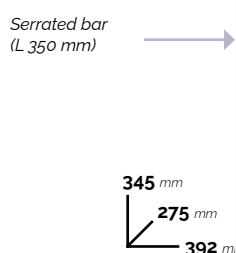

White coated steel (wall-mounted or on stand)	700014
AISI 304 s.steel (wall-mounted or on stand)	753233
White coated steel (on stand)	700030
AISI 304 s.steel (on stand)	707005
White metal sack holder	700050

ROLIND BASIC

WALL-MOUNTED INDUSTRIAL TOWEL ROLL HOLDER



- AISI 304 s.steel or powder epoxy coated steel
- Holds one roll having external Ø 260 mm
- Compatible with roll having an inner carton tube Ø 20 mm min.
- Roll holder bar 380 mm
- Paper can be cut easily with the adjustable serrated bar (350 mm)
- Plastic cones hold the roll securely in place (Ø min. 42 mm, Ø max. 55 mm)
- Wall mounted fixing not kit included



Colors available:



Wall-mounted dispenser white steel	700015
Wall-mounted dispenser 304 polished steel	700010

ROLIND EVO

WALL-MOUNTED OR ON STAND INDUSTRIAL TOWEL ROLL HOLDER

ON STAND VERSION



790 mm
350 mm
400 mm

ON STAND OR WALL-MOUNTED VERSION

AISI 304 s.steel - ABS axle, spindle and support



Wall-mounted

450 mm
190 mm
400 mm



On stand

530 mm
190 mm
400 mm



- AISI 304 s.steel
- ABS axle, spindle and support
- Max. roll diameter: Ø 500 mm
- Max. roll width: 380 mm
- Compatible with roll having an inner carton tube Ø 70 mm
- Paper can be cut easily with the adjustable plastic serrated bar



On stand industrial towel roll holder

920901

Wall-mounted or on stand industrial towel roll holder

920900



NENYA

WALL MOUNTED BATH DISPENSER, ESSENTIAL ALLY FOR PERSONAL HYGIENE

Our first line of rechargeable shower dispenser (white), whose name is **Nenya**, presents a capacity of 300 ml with wall support in ABS (black). It has been launched at the InterClean's fair show in Amsterdam. The product was thought and presented as **courtesy line** mainly for the hotel chains but also for other potential use (kitchen, restaurants etc...). We would like to invite you to find out more about our dispenser's range that allow us to avoid the use of single dose disposable cosmetic products, to be given the chance for a **more rational and eco-friendly use** of shower gel, shampoo, and conditioner. Our new reference stands out by a **key with high magnetic force** magnets and its circular form with hollow enables us to **avoid stagnation** of liquid (shower gel, shampoo etc...), encouraging a **more hygienic use**.



NENYA

WALL MOUNTED BATH DISPENSER



Locking 'clip' with magnet closure



Three labels included: shower gel, shampoo and conditioner



Locking clip



Magnetic key

- Bottle (white) with ABS wall bracket (black)
- Open circular shape to avoid stagnation of liquids (shower gel, shampoo etc.)
- Three labels included: shower gel, shampoo and conditioner
- Magnetic key lock



Wall mounted bath dispenser (300 ml)

110545

KATY

BATHROOM ACCESSORIES



- AISI 304 polished stainless steel
- Easy to install and maintain



A	Bathrobe hanger with 4 hooks	105101	G	Glass shelf	105106
B	Bath towels shelf	105102	H	Towel ring	105107
C	Double hooks bathrobe hanger	105103	I	Wall mounted toilet brush holder	105108
D	Double hooks bathrobe hanger	105203	J	Toilet paper holder with AISI 304 s.steel spindle	105109
E	Double bar towel holder	105104	K	Toilet paper holder with Plastic spindle	105041
F	Single bar towel holder	105105	L	Retractable clothes line 2.5 M	105042

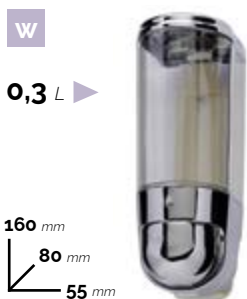
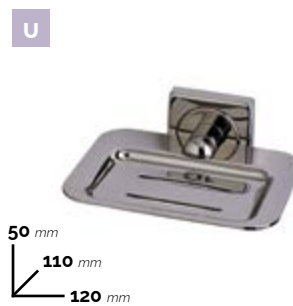
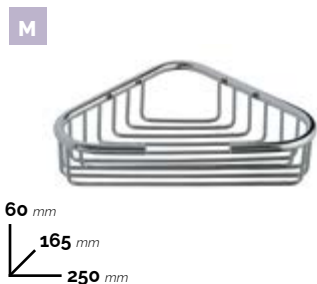

- Chromed ABS backing and transparent polycarbonate cover
- Refillable tank (0,3 L)
- For all kind of liquid soaps, except for microbead soaps



M	Corner shelf	105113
N	Soap holder	105111
O	Spare toilet paper roll holder	105112
P	3x magnifying mirror with Led light (ø 215 mm)	105119
Q	3x magnifying mirror (ø 200 mm)	130110
R	Glass toilet brush ceramics	105115

S	Toilet glass holder	105118
T	Liquid soap holder	105116
U	Soap holder	105117
V	Mirror holders (brushed finish)	105114
W	Soap dispenser tank x 0,3 L - chromed ABS	110551

SIMPLY

BATHROOM ACCESSORIES

<p>A</p>  <p>65 mm 37 mm 55 mm</p>	<p>B</p>  <p>62 mm 37 mm 110 mm</p>	<p>C</p>  <p>40 mm 140 mm 560 mm</p>	<p>D</p>  <p>40 mm 84 mm 555 mm</p>
<p>E</p>  <p>40,5 mm 125 mm 450 mm</p>	<p>F</p>  <p>160 mm 60 mm 215 mm</p>	<p>G</p>  <p>30 mm 180 mm 180 mm</p>	<p>H</p>  <p>40 mm 105 mm 130 mm</p>
<p>I</p>  <p>103 mm 93 mm 76 mm</p>	<p>J</p>  <p>360 mm 150 mm 230 mm</p>	<p>K</p>  <p>360 mm 125 mm 150 mm</p>	<p>L</p>  <p>70 mm 100 mm 170 mm</p>
<p>M</p>  <p>160 mm 130 mm 125 mm</p>	<p>N</p> <p>0,3 L ▶</p>  <p>160 mm 80 mm 55 mm</p>	<ul style="list-style-type: none"> • White ABS backing and transparent polycarbonate cover • Refillable tank (0,3 L) • For all kind of liquid soaps, except for microbead soaps <div style="display: flex; align-items: center;">    </div>	

- White ABS
- Easy to install and maintain



A	Single hook bathrobe hanger	111000	H	Soap holder	111017
B	Double hooks bathrobe hanger	111003	I	Glass holder	111018
C	Double bar towel holder	111004	J	Square toilet brush holder	906450
D	Single bar towel holder	111005	K	Corner toilet brush holder	906451
E	Shelf	111006	L	Toilet tissue roll dispenser	104101
F	Towel ring	111007	M	Toilet paper roll holder with casing	710010
G	Corner soap holder	104113	N	Soap dispenser tank x 0,3 L	110550

RELAX

TOILET SEAT



- Duroplast toilet seat
- Aluminium hinges
- Soft closing system



Duroplast toilet seat

120006

ATIS

TOILET SEAT



- Antibacterial PP toilet seat
- Antibacterial PP lid
- Soft and quiet close lid
- Rubber bumpers



Antibacterial PP toilet seat

120011

RELAX

TOILET SEAT



- White MDF toilet seat
- Plastic hinges



White MDF toilet seat

120001

LINDER

TOILET SEAT



- Antibacterial PP toilet seat
- Antibacterial PP lid
- Plastic hinges
- Rubber bumpers



Antibacterial PP toilet seat

120010

NARCISO PACK

RECTANGULAR MIRROR



- High-quality frameless glass mirror
- Special packaging in a wooden crate
- Security film
- To be hanged horizontally or vertically

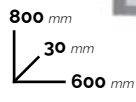

Rectangular glass mirror

710125



ACRIL

SHATTERPROOF ACRYLIC MIRROR

- Acrylic sheet (3 mm) with mirror finish
- Back wood panel (3 mm)
- Ultra-light, safe & shatterproof
- Hang with screws or double-sided tape (not included) **(do not use silicone)**
- Brushed AISI 304 s.steel swing back brackets on request (cod. 105114)



500 mm
6 mm
400 mm



700 mm
6 mm
500 mm



700 mm
6 mm
500 mm



Brushed s.steel brackets (Ref. 105114)

Shatterproof acrylic mirror rectangular 400x500mm	150010
Shatterproof acrylic mirror rectangular 500x700mm	150011
Shatterproof acrylic mirror oval 500x700mm	150012

SIMPLY

ROUND MIRROR WITH WHITE FRAME



470 mm
35 mm
470 mm



490 mm
35 mm
490 mm

- Glass mirror
- White ABS frame



Squared mirror (460x460 mm)	150000
Round mirror (Ø 500 mm)	150005

HYGIENE

HAND & HAIR DRYERS





HAND DRYERS

SELECTION GUIDE

Hand dryers have become more and more popular in public restrooms as a valid alternative to conventional drying systems. Although the implementation of these devices is shown to be a viable and effective solution in many environments, it may be quite hard to choose the product which best fits the facility's needs. The reason for this lies in the fact that there are many types of hand dryers available on the market and they differ from one another in terms of technical, functional and aesthetic features. Thus, you will never find the perfect hand dryer for a given context of use, but the one which best meets the requirements for the job.

There are six factors to be considered while choosing a hand dryer:

- 1 **the flow of people** using the public restroom, estimated in terms of daily frequency of use and concentration of device activation throughout the day
- 2 **budget**, in which you have to include the device purchase price as well as the operating costs due to maintenance and power consumption
- 3 **hand dryer's performance**, in terms of drying speed and quietness
- 4 possible **risks of vandalism**
- 5 **compliance with hygiene standards**
- 6 aspects related to **design**

	HIGH TRAFFIC AREAS	MEDIUM TRAFFIC AREAS	LOW TRAFFIC AREAS
JET DRYERS	 Twister	 Zefiro	 Mini Zefiro
SMART DRYERS	 Kari X-Dry X-Dry Compact Bayamo	 Mocka Dry Max UV Zefiro Pro UV Zefiro Hot	
TRADITIONAL HAND DRYERS		 Hamet Arielimp	 Qibli Alisé















To better meet the needs of different user segments and environments, Medial International has completed its bathroom accessories offer with two ranges of hand dryers.

Jet hand dryers take advantage of advanced motor technology, capable of circulating air at very high speed and so eliminating the water on the hands quickly. The main features of this range are high drying speed and considerable energy saving.

Smart jet hand dryers combine the high-powered jets of air to rapidly blow water off the hands with drying comfort of traditional dryers, using a heating element to warm air.

Traditional hand dryers: are equipped with a heating element, which immediately and constantly warms up the air while passing through it. These are ideal solutions for those who prefer tradition to innovation.

COMPARATIVE CHART

	Rated power	Heater	Air temperature	Noise level	Air filters	Drying time
Twister	1.750 W	x		80 dB	EPA E11 (on request)	12 - 15 sec.
Kari	1.450 W (AC) 1.300 W (B-less)	ON-OFF 550 W		78 dB	HEPA H11 (standard)	5 - 10 sec.
X-Dry	1.800 W (B-less)	ON-OFF 600 W (B-less)		75 dB	EPA E11 (standard)	12 - 15 sec.
X-Dry Compact	1.450 W	ON-OFF 350 W		75 dB	EPA E11 (standard)	12 - 15 sec.
Bayamo	1.900 W	ON-OFF 1.000 W		72 dB	AIR FILTER (standard) HEPA H11 (optional)	10 - 12 sec.
Mocka	1.350 W	ON-OFF 800 W		72 dB	AIR FILTER (standard)	12 - 15 sec.
Dry Max UV	450 - 1.000 W	ON-OFF 225 - 500 W		68-75 dB	EPA E11 (standard)	15 sec.
Zefiro Pro UV	1.100 W	ON-OFF 550 W		75 dB	EPA E11 (standard)	12 - 15 sec.
Zefiro	1.100 W	x		80 dB	EPA E11 (optional)	15 sec.
Zefiro Hot	1.100 W	550 W		75 dB	EPA E11 (optional)	15 sec.
Mini Zefiro	900 W	500 W		70 dB	EPA E11 (optional)	20 sec.
Hamet	2.400 W	2.200 W		70 dB	x	35 sec.
Arielimp	2.500 W	2.250 W		70 dB	x	35 sec.
Qibli	1.850 W	1.785 W		60 dB	x	50 sec.
Alisé	1.800 W	1.700 W		54 dB	x	50 sec.

MAINTAINANCE:

The cover must be cleaned regularly by using a mild detergent, water and a damp cloth. We recommend you choose the cleaning solution depending on the type of material to be treated. **The drain tank**, where provided, must be emptied on a weekly basis to avoid water overflows and to prevent mold and unpleasant smells from spreading.

As for dryers with brush motors, these must be replaced from time to time (on average every 1.000 hours of use) to avoid damage to motor.

The **air filter**, where provided, must be regularly cleaned with water. As for **EPA E11 filter**, it is not washable, so it must be replaced at least once a year.

As for warranty application and limitations, please consult after-sales conditions.

TWISTER



Outstanding performance and high-efficiency make Twister the ideal choice for high traffic toilets. Designed with super speedy heater-free technology, this model uses high-powered jets of air to quickly blow water off the hands. Available in silver or white finishes, Twister features a "hands-in" vertical drying style in line with current trends.



ERGONOMIC DESIGN - Twister features a wide hand drying area, opened on both sides, and a double wave-shape nozzles. This makes the dryer more comfortable and easier to use.



DOUBLE MOTOR, OUTSTANDING PERFORMANCE - Twister is operated by two brush motors which work simultaneously to reach a rated power of 1750 W. The dryer boasts a quick drying time of 12–15 seconds.



DROP-STOP SYSTEM - The special cover shape with side bars prevents water from dripping on the floor and minimizes splashes. This helps keep restrooms always clean and tidy.



DRAIN TANK - The unit incorporates a built-in drain tank that catches water droplets coming off users' hands. Being removable, the tank can be easily empty and clean, to avoid overflows, mold and bad smells.

Electrical specifications

Number of motors	2
Motor type	Ac brush motor
Total power	1750 W
Motor power	2 x 875 W
Heating element power	No heater
Voltage	220-240 V
Frequency	50-60 Hz
Electrical isolation	Class II
Electrical class protection	IP31

Construction

Casing	ABS
Dimensions (WxDxH)	300x230x650 mm
Weight	9,5 kg

Operation

Activation	Automatic infrared detector
Air speed	410 Km/h (in uscita)
Air flow	2 x 150 m ³ /h
Noise level (@ 1 M)	80 dB
Drying time	12-15 sec.

Accreditations

Quality marks	CE, RoHs
---------------	----------

Product code

White	704200
Satin-grey	704202



KARİ



"Pro" version available with BRUSHLESS motor

Thanks to its revolutionary and innovative design, Kari enriches and extends our range of electric hand dryers further. Ideal in high traffic areas, this new smart jet dryer offers an ultra fast drying experience (5-10 seconds), facilitated by the horizontal frontal opening. The product is available in the "Easy" version, with AC motor, and in the "Pro" version, with brushless motor.



AC or BRUSHLESS - The "Easy" version is supplied with an AC current motor, for a better quality-price ratio. The "Pro" version includes a brushless motor, which guarantees excellent performance and less wear over time.



360° CIRCULAR DRYING ZONE - The dryer is equipped with a large circular drying compartment. The air flow is delivered at 360°, allowing an ultra fast drying in a few seconds.



INTEGRATED ADJUSTMENT PANEL - Specific selectors allow you to activate or deactivate the heater (ON / OFF); adjust the motor power by choosing between three air speeds (Low, Medium, High).



ABSORBENT CERAMICS - The drying compartment is equipped with a ceramic plate that can absorb up to 70 g of water and withstand about 280 complete drying cycles per day.



HEPA FILTER (STANDARD) - The appliance is equipped as standard with an HEPA H11 filter, which guarantees protection against 97,66% of bacteria present in the air used during drying.



Electrical specifications

Number of motors	1
Motor type	EASY - AC brush motor PRO - Brushless motor
Total power	1.050 W - 1.450 W (EASY) 1.000 W - 1.300 W (PRO)
Motor power	550 W
Heating element power	900 W (EASY) 450 W - 750 W (PRO)
Voltage	220-240 V
Frequency	50-60 Hz
Electrical isolation	Class I
Electrical class protection	IPX4

Construction

Casing	ABS
HEPA H11 filter	Standard
Dimensions (WxDxH)	318x185x615 mm
Weight	9,6 kg

Operation

Activation	Automatic infrared detector
Air speed	EASY - 324 - 486 Km/h PRO - 270 - 396 Km/h
Air flow	89-124 m ³ /h
Noise level (@ 1 M)	78 dB
Drying time	5-10 sec.

Accreditations

Quality marks	CE, RoHs
---------------	----------

Product code

White - EASY	160020
Satin-grey - EASY	160022
White - PRO	160025
Satin-grey - PRO	160027

Accessories & spare parts

HEPA H11 filter	160965
-----------------	---------------



X-DRY



X-Dry is a next generation smart dryer designed for medium-high traffic toilets. Available with brushless motor, the product boasts excellent drying performance, using high-powered jets of air to rapidly blow water off the hands. X-Dry also incorporates a heating element capable of warming the air stream instantaneously.



BRUSHLESS MOTOR - X-Dry Pro incorporates a brushless motor for higher performance, less maintenance and top energy saving.



ADJUSTABLE HEAT CONTROL - To offer higher efficiency and greater comfort in use, the heater can be activated or deactivated according to preferences. The ON/OFF button is located at the bottom of the unit.



OVERHEATING PROTECTION - X-Dry has an in-built sensor system capable of deactivating the heating element when the air heat output reaches 30°.



DRAIN TANK - The unit incorporates a drain tank with overflow pump that catches water droplets coming off users' hands. Being removable, the tank can be easily empty and clean to both avoid overflows and bad smells.



DOUBLE EPA FILTER (AS STANDARD) - X-Dry comes as standard with two EPA E11 filter, which purify the air by trapping up to 97,66% of dust micro-particles, pollen and bacteria suspended in the incoming air flow.

Electrical specifications

Number of motors	1
Motor type	Digital Brushless
Total power	1.800 W
Motor power	1.200 W (BRUSHLESS)
Heating element power	600 W (BRUSHLESS)
Voltage	220-240 V
Frequency	50-60 Hz
Electrical isolation	Class I
Electrical class protection	IP31

Construction

Casing	ABS
EPA E11 filter	Standard
Dimensions (WxDxH)	298x170x565 mm
Weight	7.2 kg

Operation

Activation	Automatic infrared detector
Air speed	410 Km/h (in uscita)
Air flow	187 m ³ /h
Noise level (@ 1 M)	75 dB
Drying time	12-15 sec.

Accreditations

Quality marks	CE, RoHS
---------------	----------

Product code

White	704260
Satin-grey	704262

Accessories & spare parts

EPA E11 filter	704936
----------------	---------------



X-DRY COMPACT



X-Dry Compact is a smart dryer designed for medium-high traffic areas. Extremely compact in size but ergonomic in design, it offers outstanding performance with a drying time of only 12–15 seconds. To conserve energy and optimize hygiene, it also incorporates an intelligent switchable heating element for hot/cold airflow as well as a UV lamp that sanitizes the drain tank.



ULTRA-COMPACT DESIGN - Thanks to its compact size, X-Dry Compact can be easily fitted in any washroom. It's a great choice for small toilets having very tight spaces or where multiple units are required.



ADJUSTABLE HEAT CONTROL - To offer higher efficiency and greater comfort in use, the heater can be activated or deactivated according to preferences. The ON/OFF button is located at the bottom of the unit.



UV STERILIZATION - The dryer is equipped with a special ultraviolet lamp for improved bacterial control. The device is placed close to the drain tank, allowing to collect purified water.



DRAIN TANK - The unit incorporates a built-in drain tank with overflow pump that catches water droplets coming off users' hands. Being removable, the tank can be easily empty and clean to both avoid overflows and bad smells



DOUBLE EPA FILTER (AS STANDARD) -X-Dry Compact comes as standard with two EPA E11 filter, which purify the air by trapping up to 97,66% of dust micro-particles, pollen and bacteria suspended in the incoming air flow.

Electrical specifications

Number of motors	1
Motor type	Ac brush motor
Total power	1450 W
Motor power	1100 W
Heating element power	350 W
Voltage	220-240 V
Frequency	50-60 Hz
Electrical isolation	Class II
Electrical class protection	IP31

Construction

Casing	ABS
EPA E11 filter	Standard
Dimensions (WxDxH)	296x177x566mm
Weight	6,5 kg

Operation

Activation	Automatic infrared detector
Air speed	410 Km/h (output)
Air flow	187 m³/h
Noise level (@ 1 M)	75 dB
Drying time	12-15 sec.

Accreditations

Quality marks	CE, RoHS
---------------	----------

Product code

White	704255
Satin-grey	704257
Black	704259

Accessories & spare parts

EPA E11 filter	704936
----------------	---------------



BAYAMO



Blowing water from hands in less than 10 seconds, Bayamo is one of the most efficient and powerful 'hands-in' dryers on market. Super-reliable and perfect to handle heavy crowds in high traffic washrooms, this device combines top-notch technology with cutting-edge functionality. It incorporates an air sensor which detects ambient temperature, then automatically adjusting the heater.



ENHANCED HYGIENE - The shell incorporates anti-microbial and anti-UV technology, inhibiting the growth of bacteria. It is also equipped with two UV LED devices which sanitize the air stream both in the air intake and output area.



INTEGRATED ADJUSTMENT PANEL - In-built switchers allows to choose the operation mode. You can activate/deactivate the unit (ON/OFF); switch the heating element ON/OFF for instant hot air flow; adjust airflow speed (HIGH/LOW).



DRYING CYCLE QUICK CHECK - A LED screen is placed on top of the dryer, allowing the user to quickly check the drying cycle status, while two LED indicators show when the unit is working and when an error occurs.



DRAIN TANK - Bayamo incorporates a built-in drain tank with overflow pump that catches water droplets coming off users' hands. Being removable, the tank can be easily empty and clean to both avoid overflows and bad smells.



AIR/HEPA H11 FILTERS - The dryer comes as standard with a washable air prefilter. It can also incorporate a replaceable HEPA H11 filter, which traps up to 97,66% of dust micro-particles suspended in the incoming air stream.

Electrical specifications

Number of motors	1
Motor type	Ac brush motor
Total power	1900 W
Motor power	900 W
Heating element power	1000 W (ON-OFF)
Voltage	220-240 V
Frequency	50-60 Hz
Electrical isolation	Class II
Electrical class protection	IP44

Construction

Casing	Antibacterial and anti-UV ABS
Air filter	Standard
HEPA H11 filter	Optional
Dimensions (WxDxH)	300x220x700 mm
Weight	9.5 kg

Operation

Activation	Automatic infrared detector
Air speed	95 Km/h (output)
Air flow	190 m ³ /h
Noise level (@ 1 M)	72 dB
Drying time	10-12 sec.

Accreditations

Quality marks	CE, RoHS
---------------	----------

Product code

White	160010
Satin-grey	160012

Accessories & spare parts

HEPA H11 filter	160015
Box for HEPA H11 filter	160990



MOCKA



Suitable for medium traffic toilets, Mocka has a sophisticated and unconventional design since it incorporates a contoured water collection tray which catches droplets. Mocka performs as a jet dryer while offering the highest level of comfort as traditional devices do. It's also safety, as it includes a protection against overheating, overload and short-circuit.



ANTIBACTERIAL PROTECTION - The shell incorporates a special antimicrobial additive to inhibit bacteria growth. The touch-free automatic activation promotes hand hygiene, without the risk of cross-contamination by touching buttons.



ADJUSTABLE HEAT CONTROL - Depending on the user's preferences or season, the heating element can be switched on or off by pushing the dedicated controller placed on top of the drying zone area.



LED INDICATORS - The front panel includes two LED indicators, emitting green and blue light, that shows when the unit is turned on and when an error occurs.



DRAIN TANK - Water is collected in a reservoir with level window. Being removable, the tank can be easily empty and clean, to avoid overflows and to prevent mold or bad smells from spreading.



AIR FILTER (STANDARD) - The unit comes as standard with a washable air filter, ensuring protection against dust microparticles as well as other pollutants suspended in the incoming air stream.

Electrical specifications

Number of motors	1
Motor type	Ac brush motor
Total power	1350 W
Motor power	550 W
Heating element power	800 W (ON-OFF)
Voltage	220-240 V
Frequency	50-60 Hz
Electrical isolation	Class II
Electrical class protection	IP44

Construction

Casing	Antibacterial and anti-UV ABS
Air filter	Standard
Dimensions (WxDxH)	250x165x470 mm
Weight	4.7 kg

Operation

Activation	Automatic infrared detector
Air speed	360 Km/h (output)
Air flow	195 m ³ /h
Noise level (@ 1 M)	72 dB
Drying time	12-15 sec.

Accreditations

Quality marks	CE, RoHS
---------------	----------

Product code

White	160100
Satin-grey	160102

Accessories & spare parts

Air filter	160985
------------	---------------



DRY MAX UV



AVAILABLE IN AR ON **MEDIAL APP** 



Dry Max UV is a smart dryer for medium-high traffic locations. The possibility to set the air temperature allows considerable energy savings. Maximum hygiene standards are guaranteed by the presence of an antibacterial UV lamp and a EPA filter that purifies the incoming air flow.

TOUCHLESS TECHNOLOGY - The unit automatically turns on when hands pass under the infrared sensors installed in the drying area. The touch-free activation promotes hand hygiene, without the risk of cross-contamination.

ADJUSTABLE HEAT CONTROL - To offer higher efficiency and greater comfort in use, the heater can be activated or deactivated according to preferences. The ON/OFF button is located at the bottom of the unit.

UV STERILIZATION - The unit is equipped with a special ultraviolet lamp for improved bacterial control. The device is placed inside the dryer to purify the air stream.

ADJUSTMENT VARIATOR - The dryer is equipped with a variator to adjust motor speed. This component impacts on the engine RPM and therefore on the noise level of the unit.

EPA FILTER (INCLUDED) - The unit incorporates a replaceable EPA filter, which purifies the air by trapping up to 97,66% of dust microparticles and bacteria in the incoming air flow.

Electrical specifications

Number of motors	1
Motor type	Ac brush motor
Total power	450 - 1.000 W
Motor power	225 - 500 W
Heating element power	225 - 500 W (ON-OFF)
Voltage	220-240 V
Frequency	50-60 Hz
Electrical isolation	Class II
Electrical class protection	IP34

Construction

Casing	ABS - Nylon
EPA E11 filter	Standard
Dimensions (WxDxH)	180x97x280 mm
Weight	1,86 kg

Operation

Activation	Automatic infrared detector
Air speed	191 - 260 Km/h (output)
Air flow	120 m³/h
Noise level (@ 1 M)	68-75 dB
Drying time	15 sec.

Accreditations

Quality marks	CE, RoHS
---------------	----------

Product code

White	704520
Chromed	704521
Brushed	704522
Black	704529

Accessories & spare parts

EPA E11 filter	704995
----------------	---------------



ZEFIRO PRO UV



By incorporating additional and more advanced features, Zefiro Pro UV expands our offer even further. Designed for medium-high-traffic areas, this smart dryer includes an antibacterial UV lamp. Thanks to this last feature, Zefiro Pro UV is suitable for installation in sensitive locations, such as hospitals and food areas.



ENHANCED COMFORT - The drying zone with air-cone outlet shape is wide and easily accessible, making hand drying more comfortable for the majority of people while waiting.



INSTANT HOT AIR - The unit is equipped with heater, which allows you to regulate the air flow (hot or cold) according to seasonal needs or customer's preferences.



UV STERILIZATION - Zefiro Pro UV is equipped with a special ultraviolet lamp for improved bacterial control. The device is placed inside the dryer to purify the air stream.



VANDAL PROOF - The stainless steel covers are designed to withstand tampering or impacts of blunt objects thrown vigorously by vandals. These kind of covers are ideal to avoid vandal-attacks as well as in high traffic areas.



EPA FILTER (STANDARD) - Zefiro Pro UV may incorporate a replaceable EPA E11 filter which purifies the air by trapping up to 97,66% of dust microparticles, pollen and bacteria suspended in the incoming air flow.

Electrical specifications

Number of motors	1
Motor type	Ac brush motor
Total power	1100 W
Motor power	550 W
Heating element power	550 W (ON-OFF)
Voltage	220-240 V
Frequency	50-60 Hz
Electrical isolation	Class II
Electrical class protection	IP23

Construction

Casing	Polypropylene, steel, AISI 304 s.steel
EPA E11 filter	Standard
Dimensions (WxDxH)	221x157x285 mm
Weight	2,55 Kg (PP) / 3,05 Kg (inox)

Operation

Activation	Automatic infrared detector
Air speed	300 Km/h (output)
Air flow	187 m³/h
Noise level (@ 1 M)	72 dB
Drying time	12-15 sec.

Accreditations

Quality marks	CE, RoHS
---------------	----------

Product code

White polyprop	704500
White steel	704510
Polished s. steel 304	704511
Brushed s. steel 304	704512
Black steel	704519

Accessories & spare parts

EPA E11 filter	704995
----------------	---------------



ZEFIRO



Zefiro is the broadest and most complete range of hand dryers in the "jet" category. Great for medium-high traffic toilets, it incorporates a 1.100 W cost-saving brush motor, offering an ultra-fast drying time in just 15 seconds. This range is available in a wide variety of materials, finishes and air outlet shapes.



CONE OR BLADE AIR OUTLET - The dryer is available in two different outlet shape versions. The cone outlet shape conveys the air flow evenly, while the blade outlet shape makes the drying area wider.



TOP EFFICIENCY AND ENERGY SAVING - For even greater efficiencies, Zefiro has no heating element. It uses jet streams of air to dry hands in 15 seconds. Auto turn-on thanks to infra-red sensors.



SOPHISTICATED DESIGN - Thanks to its modern and sleek shape, Zefiro perfectly fits into all architectural styles. The covers rounded lines makes Zefiro easier to clean.



VANDAL PROOF - The protective aluminium outer shells are designed to withstand tampering or impacts of blunt objects thrown vigorously by vandals.



EPA FILTER (AS OPTION) - Zefiro may incorporate a replaceable EPA E11 filter which purifies the air by trapping up to 97,66% of dust microparticles suspended in the incoming air flow.

Electrical specifications

Number of motors	1
Motor type	Ac brush motor
Total power	1100 W
Motor power	1100 W
Heating element power	No heater
Voltage	220-240 V
Frequency	50-60 Hz
Electrical isolation	Class II
Electrical class protection	IP23

Construction

Casing	ABS or die cast aluminum
EPA E11 filter	Optional
Dimensions (WxDxH)	221x157x285 mm
Weight	3 kg (ABS) / 5 Kg (Alluminium)

Operation

Activation	Automatic infrared detector
Air speed	325 Km/h (output)
Air flow	187 m³/h
Noise level (@ 1 M)	80 dB
Drying time	15 sec.

Accreditations

Quality marks	CE, RoHs
---------------	----------

Product code

ZEFIRO	Cone outlet shape	Blade outlet shape
White ABS	704350	704300
White aluminium	704360	704310
Chromed aluminium	704361	704311
Brushed aluminium	704362	704312
Blue ABS		704300STBL
Black ABS		704309

Accessories & spare parts

EPA E11 filter	704995
----------------	---------------



ZEFIRO HOT



Unlike the other dryers from the same range, Zefiro Hot includes a 550 W heater which allows to warm the drying flow from the first instants of use. Entirely designed and manufactured in Italy, this dryer is operated by a reliable 550 W brush motor. Delivering a powerful airflow at an output speed of 250 km/h, Zefiro Hot offers perfect drying in just 15 seconds, while optimizing energy consumption.



ENHANCED COMFORT - The drying zone with air-blade outlet shape is wide and easily accessible, making hand drying more comfortable for the majority of people while waiting.



INSTANT HOT AIR - Zefiro Hot is equipped with heater, an element that allows for the instantaneous preparation of hot air contributing to increased comfort during the winter.



VANDAL PROOF - The aluminum covers are designed to withstand tampering or impacts of blunt objects thrown vigorously by vandals. These kind of covers are ideal in high traffic areas.



SOPHISTICATED DESIGN - Thanks to its modern and elegant shape, Zefiro Hot perfectly fits into all washrooms. The covers rounded lines makes Zefiro Hot easier to clean.



EPA FILTER (AS OPTION) - Zefiro Hot may incorporate a replaceable EPA E11 filter which purifies the air by trapping up to 97,66% of dust microparticles suspended in the incoming air flow.



Electrical specifications	
Number of motors	1
Motor type	Ac brush motor
Total power	1100 W
Motor power	550 W
Heating element power	550 W
Voltage	220-240 V
Frequency	50-60 Hz
Electrical isolation	Class II
Electrical class protection	IP23
Construction	
Casing	ABS or die cast aluminum
EPA E11 filter	Optional
Dimensions (WxDxH)	221x157x285 mm
Weight	3 Kg (ABS) / 5 Kg (Alluminium)
Operation	
Activation	Automatic infrared detector
Air speed	250 Km/h (in uscita)
Air flow	126 m³/h
Noise level (@ 1 M)	75 dB
Drying time	15 sec.
Accreditations	
Quality marks	CE, RoHS
Product code	
White ABS	704325
White aluminium	704335
Chromed aluminium	704336
Brushed aluminium	704337
Accessories & spare parts	
EPA E11 filter	704995

MINI ZEFIRO



Mini Zefiro is the ideal solution for any small restroom requiring an efficient drying system. Operated by a heater-free 900 W motor, this dryer is even more powerful and cost-effective when compared to larger models in the same segment. A great choice for medium-low washroom environments, Mini Zefiro perfectly dries the hands in just 20 seconds.



ENERGY-SAVING - Designed with super speedy technology in mind, Mini Zefiro is operated by a powerful 400 AC motor, incorporating a 500 W heating element. This massively lowers the energy consumption.



INSTANT WARM AIR - To offer a greater comfort in use, the dryer incorporates a heater that instantly warms the air during hand drying operations.

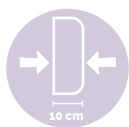

ULTRA-COMPACT DESIGN - It comes with an ultra-compact shape, only 10 cm depth. Nevertheless, the wide cone nozzle design spreads airflow across a large area, ensuring both hands are dried at the same time.



AUTOMATIC ACTIVATION - The dryer is equipped with an effective infrared sensor which detects the hands placed below the dryer, thereby activating a 200 km/h air stream.



EPA FILTER (AS OPTION) - Mini Zefiro may incorporate a replaceable EPA E11 filter which purifies the air by trapping up to 97,66% of dust microparticles suspended in the incoming air flow.

Electrical specifications

Number of motors	1
Motor type	Ac brush motor
Total power	900 W
Motor power	400 W
Heating element power	500 W
Voltage	220-240 V
Frequency	50-60 Hz
Electrical isolation	Class II
Electrical class protection	IP23

Construction

Casing	ABS
EPA E11 filter	Optional
Dimensions (WxDxH)	156x99,5x238 mm
Weight	1,2 kg

Operation

Activation	Automatic infrared detector
Air speed	200 Km/h (output)
Air flow	110 m ³ /h
Noise level (@ 1 M)	70 dB
Drying time	20 sec.

Accreditations

Quality marks	CE, RoHs
---------------	----------

Product code

White	704390
Black	704399
Chromed	704391
Brushed	704392

Accessories & spare parts

EPA E11 filter	704973
----------------	---------------



HAMET



Hamet is the most popular and requested conventional hand dryer, so much so that it represents a standard in terms of performance, reliability and security within the traditional dryer category. Operated by a powerful 2.400 W motor with a heating element, Hamet offers a quick and comfortable drying experience. A great choice in leisure facilities and gas stations.



EASY TO USE - It offers a conventional "hands-under" drying style. The dryer comes with a 360° rotating nozzle, enabling users with varying levels of mobility to dry themselves comfortably and effectively.



INSTANT HOT AIR - The dryer incorporates a heater, an element that allows for the instantaneous preparation of hot air contributing to increased comfort during the winter.



TWO TYPES OF ACTIVATION - The automatic version takes advantage of infrared sensors to detect the hands once placed under the blower. Hamet is also available with a traditional push button activation.



ADJUSTABLE TIMER - The push-activation version also incorporates an adjustable timer which allows to set the drying time from 30 seconds to 3 minutes.



VANDAL PROOF - The protective steel outer shells are designed to withstand tampering or impacts of blunt objects thrown vigorously by vandals.

Electrical specifications	
Number of motors	1
Motor type	Ac brush motor
Total power	2.400 W
Motor power	200 W
Heating element power	2.200 W
Voltage	220-240 V
Frequency	50-60 Hz
Electrical isolation	Class I
Electrical class protection	IPX1
Construction	
Casing	Vandal proof steel or s.steel AISI 304
Air filter	Not available
Dimensions (WxDxH)	278x213x243 mm
Weight	7 Kg
Operation	
Activation	Push button or automatic (infra-red detector)
Air speed	101 Km/h (output)
Air flow	330 m ³ /h
Noise level (@ 1 M)	70 dB
Drying time	35 sec.
Accreditations	
Quality marks	CE, RoHS
Product code - HAMET "push button activation"	
White steel	704175
Polished 304 s.steel	704176
Brushed 304 s.steel	704177
Product code - HAMET "sensor activation"	
White steel	704150
Polished 304 s.steel	704151
Brushed 304 s.steel	704152



ARIELIMP



Arielimp is a traditional hand dryer equipped with a sturdy vandal proof steel cover. Designed for medium-high traffic environments, this device is operated by a powerful brush motor which produces an abundant warm air flow passing through a wide nozzle. It comes with an infrared sensor for handsfree use and a built-in safety feature to automatically shut the dryer off after 180 seconds.



COMFORT IN USE - Arielimp offers a conventional "hands-under" drying style. The drying zone is wide and easily accessible by anyone, enabling users with varying levels of mobility to dry themselves effectively.



INSTANT HOT AIR - The dryer incorporates a heater, an element that allows for the instantaneous preparation of hot air contributing to increased comfort during the winter.



TOUCHLESS TECHNOLOGY - Arielimp automatically turns on when hands are placed underneath the air outlet. The touch-free automatic activation promotes hand hygiene, without the risk of cross-contamination.



VANDAL PROOF - The stainless steel covers are designed to withstand tampering or impacts of blunt objects thrown vigorously by vandals. These kinds of covers are ideal in high traffic areas.



360° ROTATING NOZZLE - The dryer comes with a 360° rotating nozzle, enabling hands, faces, hair or clothes to be dried safely and easily. This feature makes Arielimp great for leisure facilities and gas stations.

Electrical specifications

Number of motors	1
Motor type	Ac brush motor
Total power	2.500 W
Motor power	250 W
Heating element power	2.250 W
Voltage	220-240 V
Frequency	50-60 Hz
Electrical isolation	Class I
Electrical class protection	IPX1

Construction

Casing	AISI 304 s.steel
Air filter	Not available
Dimensions (WxDxH)	260x200x235 mm
Weight	4,6 kg

Operation

Activation	Automatic infrared detector
Air speed	101 Km/h (output)
Air flow	270 m ³ /h
Noise level (@ 1 M)	70 dB
Drying time	35 sec.

Accreditations

Quality marks	CE, RoHs
---------------	----------

Product code

White steel	ARIELIMPF
Polished 304 s.steel	ARIELIMPLF
Brushed 304 s.steel	ARIELIMPFS



QIBLI



Qibli is a traditional hand dryer with a sleek and contemporary design. Great in medium-low traffic toilets, it works diligently drying hands in about 50 seconds. Qibli is available in three different finishes, while there are two types of activation. This is the ideal solution for those who look for a reliable and quiet hand dryer, at a fair and value-for-money ratio.



RELIABLE - Qibli is operated by a brushless motor. This technology not only extends the dryer life cycle, but it also helps minimize maintenance, as it does not incorporate consumable parts to replace over time.



INSTANT HOT AIR - The dryer incorporates a heating element that is designed to instantly warm the air stream coming from the blower as soon as the device is activated.



TWO TYPES OF ACTIVATION - The automatic version takes advantage of infrared sensors to detect the hands once placed under the blower fan. It is also available with push button activation and adjustable timer to set the drying time from 30 sec. to 3 min.



COMPACT SIZE - Thanks to its compact size, Qibli boasts many flexible installation options. It's great choice for small toilets having tight spaces or where multiple units are required.



QUIET - By delivering an air volume of 45 l/s dispensed at a maximum speed of 80 km/h, this dryer ensures an effective but also silent drying, as it emits just 60 dB of noise whilst operating.

Electrical specifications

Number of motors	1
Motor type	Ac brushless motor
Total power	1.850 W
Motor power	65 W
Heating element power	1.785 W
Voltage	220-240 V
Frequency	50-60 Hz
Electrical isolation	Class II
Electrical class protection	IPX2

Construction

Casing	ABS
Air filter	Not available
Dimensions (WxDxH)	262x165x305 mm
Weight	3 Kg

Operation

Activation	Push button or automatic (infra-red detector)
Air speed	80 Km/h (output)
Air flow	160 m ³ /h
Noise level (@ 1 M)	60 dB
Drying time	50 sec.

Accreditations

Quality marks	CE, RoHs
---------------	----------

Product code - QIBLI "push button activation"

White	704125
-------	---------------

Product code - QIBLI "sensor activation"

White	704100
Chromed	704101
Brushed	704102



ALISÉ



Cost-saving, compact and quiet. Alisé is a traditional hand dryer operated by a reliable brushless motor. Automatically activated by infrared sensor, the unit emits an hot air flow which passes through a very wide outlet hole located at the bottom of the dryer. Alisé offers a perfect balance between performance and aesthetic, for a very reasonable price.



BRUSHLESS TECHNOLOGY - Alisé is operated by a brushless motor. This technology offers incredible efficiency and increased power delivery, resulting in less wear and increased longevity of the dryer.



INSTANT HOT AIR - To offer a greater comfort in use, the dryer incorporates a heater that instantly warms the air during hand drying operations.



TOUCHLESS TECHNOLOGY - Alisé automatically turns on when hands pass under the infrared sensors installed in the drying area. The touch-free activation promotes hand hygiene, without the risk of cross-contamination.



OVERHEATING PROTECTION - When infrared sensor is blocked for a long time, blower fan has a breakdown, or the dryer temperature exceeds safety limits, the overheating protection stops the dryer automatically.



ULTRA QUIET - Emitting just 54 dB of sound while operating, Alisé is one of the quietest hand dryers currently available on market. A great choice for noise-sensitive environments such as small restaurants.

Electrical specifications

Number of motors	1
Motor type	Ac brushless motor
Total power	1.800 W
Motor power	100 W
Heating element power	1.700 W
Voltage	220-240 V
Frequency	50-60 Hz
Electrical isolation	Class II
Electrical class protection	IPX1

Construction

Casing	ABS
Air filter	Not available
Dimensions (WxDxH)	235x215x215 mm
Weight	2,3 kg

Operation

Activation	Automatic infrared detector
Air speed	16 m/s (output)
Air flow	160 m ³ /h
Noise level (@ 1 M)	54 dB
Drying time	50 sec.

Accreditations

Quality marks	CE, RoHs
---------------	----------

Product code

White	111500
Silver gray	111502





ZEFIRO PRO HAIR

WALL-MOUNTED HAIR DRYER FOR HIGH TRAFFIC AREAS



285 mm
157 mm
221 mm

Colors available:



- Dryer casing made from polypropylene or s.steel
- Brush motor - total power: 1.100 W
- Motor power: 550 W; Heater power: 550 W
- Voltage: 220 - 240 V; Frequency: 50 - 60 Hz
- Double overheating protection included
- Push button activation placed on the cover
- Auto turn-off in 40 seconds
- Flexible hose (L: 60 - 120 cm)
- Electrical isolation/class protection: Class II-IP23



Activation button

Wall-mounted hair dryer white polypropylene + hose **704550**

Wall-mounted hair dryer white s.steel + hose **704560**

Wall-mounted hair dryer polished 304 s.steel + hose **704561**

Wall-mounted hair dryer brushed 304 s.steel + hose **704562**

HAMET

WALL-MOUNTED HAIR DRYER FOR HIGH TRAFFIC AREAS



243 mm
213 mm
278 mm

- Dryer casing made from white vandal-proof steel
- Brush motor - total power: 1.200 W
- Motor power: 200 W; Heater power: 1.000 W
- Voltage: 220 - 240 V; Frequency: 50 - 60 Hz
- Double overheating protection included
- Push button activation
- Adjustable drying time (30 sec.-3 min.)
- Flexible hose (Ø: 46 mm; L: 1 mt)
- Electrical isolation / class protection: Class I-IP20



White Hamet with hose

704075

HAMET SALI & SCENDI

WALL-MOUNTED HAIR DRYER FOR HIGH TRAFFIC AREAS



243 mm
213 mm
278 mm

1000 mm
150 mm
300 mm

- Dryer casing made from white vandal-proof steel
- Brush motor - total power: 2.400 W
- Motor power: 200 W; Heater power: 2.200 W
- Voltage: 220 - 240 V; Frequency: 50 - 60 Hz
- Double overheating protection included
- Push button activation
- Adjustable drying time (30 sec.-3 min.)
- Electrical isolation / class protection: Class I-IP20
- Optional height adjuster from AISI 304 polished s.steel
- Ideal in sport centres, spas and manufacturing facilities



White Hamet

704080

Height adjuster for Hamet

704085

YUL PRO FIT

HAIR DRYER WITH WALL BRACKET FOR HIGH TRAFFIC AREAS



Colors available:



287 mm
95 mm
275 mm



Wall bracket

SPECIFICATIONS

- Dryer casing made from white or black ABS
- Max. 1.000 W AC motor
- Motor power: 100 W; Heater power: 900 W
- Voltage: 220 - 240 V; Frequency: 50 - 60 Hz
- Activation / release by push button
- 2 air speed / temperature settings
- Air concentrator nozzle included
- Black wall mount base included ("plus" version)
- Electrical isolation / class protection: Class II
- Ideal in sport centers, gyms, etc.



White Yul Pro Fit hair dryer	704025
Black Yul Pro Fit hair dryer	704026
White Yul Pro Fit hair dryer + black wall base	704027
Black Yul Pro Fit hair dryer + black wall base	704028

QIBLI HAIR

WALL-MOUNTED HAIR DRYER FOR MEDIUM TRAFFIC AREAS



305 mm
165 mm
262 mm

- Dryer casing made from white ABS
- Brushless motor - total power: 1.200 W
- Voltage: 220 - 240 V; Frequency: 50 - 60 Hz
- Overheating protection included
- Push button activation
- Adjustable drying time (30 sec.-3 min.)
- Electrical isolation / class protection: Class II-IPX2
- Ideal in medium traffic areas



Wall-mounted hair dryer white ABS	704070
-----------------------------------	---------------

YUL TUBO

WALL-MOUNTED HAIR DRYER FOR HOTEL USE



517 mm
93 mm
140 mm



Shaver Socket

- Dryer casing made from white ABS
- Max. 700 W AC motor
- Voltage: 220 - 240 V; Frequency: 50 - 60 Hz
- Overheating protection included
- Auto turn on when hose is released
- Auto turn off after 5 minutes
- 2 air speed / temperature settings
- Shaver socket (220 / 110V) included in the wall base
- Electrical isolation / class protection: Class II



Wall-mounted hair dryer white ABS with hose

704050

YUL ATELIER

WALL-MOUNTED HAIR DRYER FOR HOTEL USE



590 mm
117 mm
184 mm

- Dryer casing made from white ABS
- Max. 900 W AC motor
- Voltage: 220 - 240 V; Frequency: 50 - 60 Hz
- Overheating protection included
- Auto turn on when hose is released
- Auto turn off after 10 minutes
- 3 air speed / temperature settings
- Shaver socket included in the wall base
- Electrical isolation / class protection: Class II



Wall-mounted hair dryer white ABS with hose

704055

YUL PASSION

WALL-MOUNTED HAIR DRYER FOR HOTEL USE



280 mm
108 mm
190 mm

Colors available:



Spiral cable 50 cm + linear 120 cm Italy plug



ABS wall bracket versions available



3 temperature settings, with LED indicator light (cold - warm - hot)

- Matt white or matt black ABS shell
- Brushless motor
- Total absorption max. 1500 W (2 regulations)
- Voltage: 220 - 240 V; Frequency: 50 - 60 Hz
- Activation with release button
- 2 speed and 3 temperature settings
- Removable filter
- Safety thermostat on heating element
- Air concentrator with magnetic coupling
- Ion generator
- Electrical isolation: Class II



Matt white hair dryer YUL PASSION	704030
Matt black hair dryer YUL PASSION	704031
Matt white hair dryer YUL PASSION + wall bracket	704032
Matt black hair dryer YUL PASSION + wall bracket	704033

YUL PRO

WALL-MOUNTED HAIR DRYER FOR HOTEL USE

Standard version



218 mm
90 mm
260 mm

- Dryer casing made from ABS and s.steel
- Max. 1.300 W professional AC motor
- Voltage: 220 - 240 V; Frequency: 50 - 60 Hz
- Overheating protection included
- Activation / release by push button
- 2 air speed / temperature settings
- Wall base and/or shaver socket as options
- ON/OFF switch included in the wall base
- Electrical isolation / class protection: Class II



Wall base version



260 mm
142,5 mm
228 mm

Wall base & shaver socket version



260 mm
155 mm
228 mm

Yul Pro with wall base	704010
Yul Pro wall base and shaver socket	704011
Yul Pro standard version (3M linear cable)	704012

YUL PRO ABS

HAIR DRYER FOR HOTEL USE



287 mm
95 mm
275 mm



- Dryer casing made from white or black ABS
- Max. 1.800 W professional AC motor
- Voltage: 220 - 240 V; Frequency: 50 - 60 Hz
- Activation / release by push button
- 2 air speed / 3 air temperature settings
- Air concentrator included
- Chromed brass wall holder as option
- Electrical isolation / class protection: Class II



Wall bracket

Hair dryer white Yul Pro	704020
Hair dryer black Yul Pro	704021
Wall base	704029

PHONETTE

WALL-MOUNTED HAIR DRYER FOR HOTEL USE



- Dryer and wall-base casing made from white ABS
- Max. 1500 W permanent magnet motor
- Voltage: 220 - 240 V; Frequency: 50 - 60 Hz
- Overheating protection included
- Activation / release by push button
- 3 air speed / temperature settings
- Shaver socket (220/110 V) included in the wall base
- ON/OFF safety switch button in the wall base
- Protection level: Class II-IP21



Hair dryer Phonette shaver socket

704003

YUL COMFORT

WALL-MOUNTED HAIR DRYER FOR HOTEL USE



- Dryer and wall-base casing made from white ABS
- Max. 1800 W permanent magnet motor
- Voltage: 220 - 240 V; Frequency: 50 - 60 Hz
- Overheating protection included
- Activation / release by push button
- 3 air speed/temperature settings
- ON/OFF safety switch button on the wall base
- Protection level: Class II



Hair dryer Yul Comfort

704004

YUL SPACE

WALL-MOUNTED HAIR DRYER WITH FOLDABLE HANDLE FOR HOTEL USE

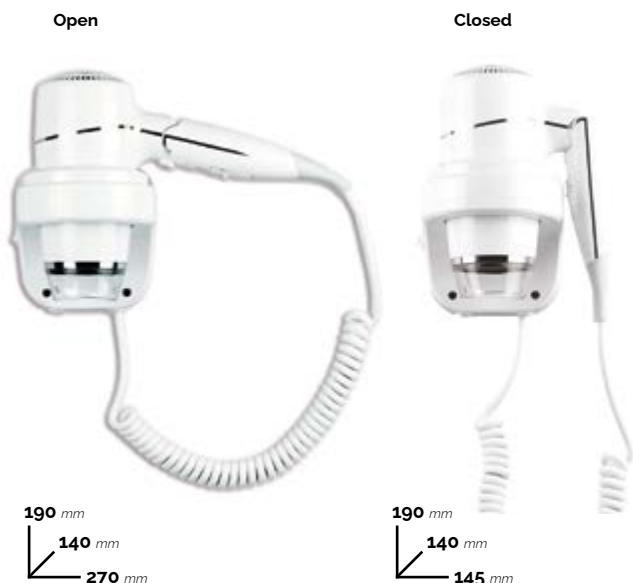

- Dryer and wall-base casing made from white ABS
- 1.650 W permanent magnet motor
- Voltage: 220 - 240 V; Frequency: 50 - 60 Hz
- Overheating protection included
- Activation/release by push button
- 3 air speed/temperature settings
- Foldable handle to save space
- ON/OFF switch included in the wall base
- Electrical isolation/class protection: Class II



Hair dryer Yul Space

704005

YUL BASIC

WALL MOUNTED HAIR DRYER FOR HOTEL USE



- Dryer and wall-base casing made from white ABS
- 1.200 W permanent magnet motor
- Voltage: 220 - 240 V; Frequency: 50 - 60 Hz
- Overheating protection included
- Activation / release by push button
- 2 air speed/air temperature settings
- ON/OFF safety switch button in the wall base
- Electrical isolation / class protection: Class II



Hair dryer Front Yul basic

704000

Hair dryer Yul Basic with shaver socket

704001

Hair dryer Side Yul Basic

704002

HYGIENE

**PERSONAL
CARE**





MILADY

THE RANGE OF **SANITARY PADS DISPENSERS**

Medial enhances the **female universe**. This sense of closeness takes shape through the introduction of a new product conceived with the aspiration to be functional and reassuring in times of need, **providing a concrete help that can mitigate a possible feeling of unease**. Medial is pleased to launch Milady, its first dispenser for women's sanitary pads with three different possibilities of use depending on the need. The product can be used in public toilets of schools, hospitals, offices, restaurants, hotels and in all situations of possible usage.



MILADY

SANITARY PADS DISPENSER



3 FLUX ▶



415 mm
135 mm
375 mm

2 FLUX ▶



415 mm
135 mm
300 mm

1 FLUX ▶



415 mm
135 mm
170 mm

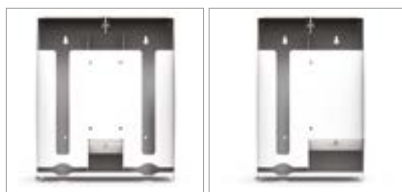

Refill compartments



Key and Lock



Vers. 2 / 3 flux

Adjustable reducer for tampons without applicator

- Galvanised steel coated with polyester powder
- White colour RAL 9003
- For feminine folded sanitary pads or/and feminine internal tampons (max L 12,5 cm)
- One, two or three compartments for different types of sanitary pads
- Customized "women" versions with labels applied (2 and 3 fluxes)
- Labels included



Sanitary pads dispenser 3 flux

789100

Sanitary pads dispenser 2 flux

789102

Sanitary pads dispenser 1 flux

789101

AVAILABLE IN AR ON MEDIAL APP



MILADY

SANITARY PADS DISPENSER- "WOMEN VERSION"



3 FLUX ▶

415 mm
135 mm
375 mm

2 FLUX ▶

415 mm
135 mm
300 mm

Sanitary pads dispenser (Vers. "Women") 3 flux **789105**

Sanitary pads dispenser (Vers. "Women") 2 flux **789107**

COMPLETE THE RANGE WITH:

ORGANYC

100% ORGANIC COTTON DAILY SANITARY PADS

▶ Ref. 701100

Page 210



COMPLETE THE RANGE WITH:

ORGANYC

100% ORGANIC COTTON DIGITAL TAMPONS

▶ Ref. 701110

▶ Ref. 701111

Page 210



COMPLETE THE RANGE WITH:

QUIK

DAYLY SANITARY PADS ULTRA QUIK

▶ Ref. 701120

Page 210



COMPLETE THE RANGE WITH:

AMÉLIE

AUTOMATIC MURAL TRASH CAN

Black

12 L ▶ Ref. 111211

White

12 L ▶ Ref. 111213

Page 42

12 L ▶

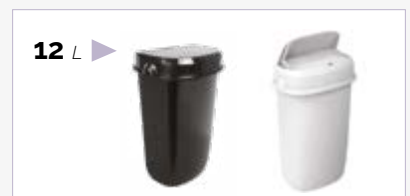

BABY CHAIR

WALL-MOUNTED SAFETY SEAT



CLOSED

OPEN



475 mm
145 mm
310 mm

- Durable and antibacterial HDPE
- Internal aluminium structure
- Safety belt included
- Up to 15kg weight
- Pictogram sticker and installation kit included
- Recommended installation height: 350 mm above floor level



Compliant with regulations:
EN 12221-1:2008+A1:2013
EN 12221-2:2008+A1:2013



Wall-mounted safety seat

117102

NINNA

BABY CHANGING TABLE



890 mm
890 mm
550 mm

VERTICAL

- White high-quality HDPE unit with compact profile
- Full length steel-on-steel hinges and pneumatic cylinder
- Steel mounting back plates
- Adjustable child safety belt from nylon
- Comfortable and safe changing table
- Sticker and mounting kit included
- Tested up to 15 Kg max. weight
- In compliance with CE council directive 93/42/EEC, annex V



Compliant with regulations:
EN 12221-1:2008+A1:2013
EN 12221-2:2008+A1:2013



480 mm
489 mm
895 mm

HORIZONTAL

Horizontal baby changing station

117101

Vertical baby changing station

117106

COPRIFACILE KIT

BULK DISPOSABLE PPE DISPENSER



- Backplate and cover from AISI 304 polished s.steel
- Suitable for single-use clothing (caps, masks, shoe-covers, etc.)
- Plastic seal to facilitate the release
- Upper lid opening to facilitate the refill operation
- Fixing kit and consumable not included



348 mm
123 mm
132 mm

Bulk disposable PPE dispenser

773025

BRINOX

TRIPLE DISPENSER OF DISPOSABLE GLOVES



- AISI 304 stainless steel, with polished finish
- Holds up to 3 glove boxes
- Max. box. dim. (LxDxH): 24x6,5x11 cm
- Allow easy access to many sizes of gloves
- Wall mount fastening





350 mm
73 mm
245 mm

Triple dispenser of disposable gloves

773021

COPRIFACILE PRO 50

AUTOMATIC SHOE COVER DISPENSER

-  2 packs x 50 covers
-  205 x 115 mm
- 13 µm



190 mm
520 mm
230 mm



- Sturdy white ABS case with blue finishes
- Mechanic operation, no need for batteries nor electricity
- Capacity up to 50 shoe covers
- Refills in PE (13 micron)





ABS shoe cover dispenser	110020
PE shoe cover refills (13 micron)	110071



COPRIFACILE

AUTOMATIC SHOE COVER DISPENSER

REFILLS PE - 110050

-  5 packs x 100 covers
-  205 x 115 mm
- 8 µm

REFILLS TNT - 110053

-  4 packs x 30 covers
-  205 x 115 mm
- 24 g/m²



140 mm
430 mm
220 mm

120 mm
400 mm
205 mm



- Aluminum or ABS casing
- It mechanically dispenses shoe covers as you step into it
- Support booties (PE or TNT shoe covers)



Aluminum shoe cover dispenser	110001
ABS shoe cover dispenser	110006
PE shoe cover refills (8 micron)	110050
Non-woven shoe cover refills	110053

COPRIFACILE

BULK DISPOSABLE SHOE COVERS

-  40 packs x 100 covers
-  375 x 145 mm
- 1.9 g



- Disposable polyethylene shoe covers (1,9 g)
- Water-resistant, hygienic, and protective
- One-size-fits-all, with elastic for easy application
- Each pack includes 100 shoe covers
- Each carton includes 40 packs



Bulk disposable shoe covers	130754
-----------------------------	---------------

METAL PHARMA UNO

FIRST AID WALL CABINET (1 DOOR)



450 mm
150 mm
360 mm

- Powder epoxy coated steel body
- Two fixed shelves
- Metal keyed lock
- First aid supplies not included



Metal Pharma 1 door

107001

METAL PHARMA DUE

FIRST AID WALL CABINET 2 DOORS



540 mm
200 mm
520 mm

- Powder epoxy coated steel body
- Twelve fixed coated steel shelves
- Metal keyed lock
- First aid supplies not included



Metal Pharma 2 doors

107002

PLASTIC PHARMA

FIRST AID WALL CABINET



400 mm
127 mm
275 mm

- RC plastic / white coloured
- 3 spaces, 2 shelves, snap lock
- First aid supplies not included



Plastic Pharma 1 door

709011

PLASTIC PHARMA

FIRST AID WALL CABINET + FIRST AID KIT #2



X 2

340 mm
120 mm
225 mm

- Polypropylene cabinet, suitable for any area
- First aid kit #2 included



Plastic Pharma + First aid kit #2

702517

VALIGIA

PLASTIC BOX FOR FIRST AID KIT



270 mm
135 mm
395 mm



190 mm
90 mm
250 mm

- Sealable polypropylene case
- Handle hanger for easy handling
- Wall bracket included
- First aid supplies not included



Wall bracket

Colors available:



Small white box	709013
Big white box	709012
Big orange box	709014

PLASTIC PHARMA

SMALL PLASTIC BOX + FIRST AID KIT #2



x 2

209 mm
97 mm
309 mm

- Ergonomic polypropylene case with gasket
- Sturdy wall bracket included
- Convenient size great for any kind of travel
- First aid kit #2 included



Case + First aid kit #2	702518
-------------------------	--------

LARGE PLASTIC BOX + FIRST AID KIT #1



x 3+

300 mm
114 mm
405 mm

- Ergonomic polypropylene case with gasket
- Handle hanger for easy handling
- Sturdy wall bracket included
- Convenient size great for any kind of travel
- First aid kit #1 included



Case + First aid kit #1	702519
-------------------------	--------

PACCO MEDICAZIONE

- First aid kit #2 - First aid supplies for up to 2 people
- First aid kit #1 - First aid supplies for more than 3 people
- Refill for first aid kit #1 - Without blood pressure meter



x 2

Up to 2 people

702590



x 3+

3 or more people

702589



x 3+

Refills

702591



x 2

Up to 2 people

PM090



x 3+

3 or more people

PM089



x 3+

Refills

PM091

LIST OF ITEMS CONTAINED IN THE BOX

FIRST AID KIT #1

5 pairs of disposable sterile gloves - 1 bottle of povidone skin solution bottle (10% iodine) 500 ml - 3 bottles of physiological solution bottle (0,9% sodium) 500 ml - 3 pcs of sterile pads (10x10 cm) in single packs - 10 pcs of sterile pads (18x40 cm) in single packs - 2 pcs of disposable sterile forceps - 2 packs of absorbent cotton - 1 box of ready-to-use adhesive bandages (available in different sizes) - 2 pcs of plaster roll (2,5 cm width) - 2 pc of protection visor - 1 pair of scissors - 1 pc of tourniquet - 3 pcs of ready-to-use ice - 2 pcs of disposable and sterile sheets - 2 pcs of elastic net - 1 pc of digital thermometer - 1 pc of blood pressure meter - 1 pc of first aid facts guide.

FIRST AID KIT #2

2 pairs of disposable sterile gloves - 1 bottle of povidone skin solution bottle (10% iodine) 125 ml - 1 bottle of physiological solution bottle (0,9% sodium) 500 ml - 1 pc of sterile pads (10x10 cm) in single packs - 3 pcs of sterile pads (18x40 cm) in single packs - 1 pc of disposable sterile forceps - 1 packs of absorbent cotton - 1 box of ready-to-use adhesive bandages (available in different sizes) - 1 pc of plaster roll (2,5 cm width) - 1 pair of scissors - 1 pc of tourniquet - 1 pc of ready-to-use ice - 1 pc of disposable sanitary bag - 1 pc of disposable and sterile sheets - 1 pc of first aid facts guide.

LIST OF ITEMS CONTAINED IN THE BOX

5 pairs of disposable sterile gloves - 1 bottle of povidone skin solution bottle (10% iodine) 500 ml - 2 bottles of physiological solution bottle (0,9% sodium) 500 ml - 3 pcs of sterile pads (10x10 cm) in single packs - 10 pcs of sterile pads (18x40 cm) in single packs - 2 pcs of disposable sterile forceps - 2 packs of absorbent cotton - 1 box of ready-to-use adhesive bandages (available in different sizes) - 2 pcs of plaster roll (2,5 cm width) - 2 pc of protection visor - 1 pair of scissors - 1 pc of tourniquet - 3 pcs of ready-to-use ice - 1 pc of disposable sanitary bag - 2 pcs of elastic net - 1 pc of digital thermometer - 1 pc of first aid facts guide.

ECO SOAP LC

LIQUID HAND SOAP



5 L ▶



250 mm
190 mm
160 mm

- Gently cleanses the hands, by leaving the skin soft
- Pleasant talc scent on skin; available in pink or white version
- To be used with manual pump or soap dispenser
- 5 L tank (sold 4-pack)



Liquid hand soap - 5 L	85000330
Liquid hand soap "WHITE" - 5 L	85000430

ECO SOAP

LIQUID HAND SOAP WITH ANTIBACTERIAL



1 L ▶

5 L ▶



250 mm
85 mm

250 mm
190 mm
160 mm

- Gently cleanses and sanitizes the hands, by leaving the skin soft
- Preserves the hydrolipidic skin balance and gives a pleasant flower scent
- Professional formula, with antibacterial; compliant with HACCP protocols
- Ecological, does not contain anionic surfactants / SLES
- 1 L bottle (9 units/box) or 5 L tank (sold 4-pack)



Liquid hand soap with antibacterial - 1 L	85000123
Liquid hand soap with antibacterial - 5 L	85000130

ECO FOAM

FOAM SOAP WITH WITH ANTIBACTERIAL



1 L ▶



250 mm
85 mm

- Ready-to-use pH-neutral foam hand wash solution
- Preserves the hydrolipidic skin balance and gives a pleasant flower scent
- Professional formula, with antibacterial; compliant with HACCP protocols
- Ecological, does not contain anionic surfactants / SLES
- 1 L bottle (9 units per box)



Foam hand soap with antibacterial 1 L	85000223
---------------------------------------	----------

ORGANYC

100% ORGANIC COTTON DAILY SANITARY PADS



50 blister
x 10 pads



- 100 % organic cotton
- GOTS-certified
- Blister of 10 pcs. in Mater-BI
- Sales carton of 50 blisters (total 500 pcs)
- Moderate flow
- Protective wings for better protection and adhesion
- Hypoallergenic and breathable
- Absorbency >35g



100% organic cotton daily sanitary pads

701100

QUIK

DAILY SANITARY PADS ULTRA QUIK



24 blister
x 12 pads

- Non-woven fabric absorbent
- Latex free
- Acquisition time ≤ 15
- Blister of 12 pcs
- Pack of 24 blisters (tot 288 pcs)



Daily sanitary pads Ultra Quik

701120

ORGANYC

100% ORGANIC COTTON DIGITAL TAMPONS



VERS. REGULAR

18 packs
x 64 tampons



- 100 % organic cotton
- GOTS-certified
- Regular flow 6-9 g
- Vers. regular 18 packs of 64 pcs (tot 1152 pcs)
- Vers. with applicator 36 packs of 16 pcs (tot. 576 pcs)
- Cardboard applicator



VERS. WITH APPLICATOR

36 packs
x 16 tampons

100% organic cotton digital tampons (Vers. Regular)

701110

100% organic cotton digital tampons (Vers. with Applicator)

701111

SACCHETTI

PLASTIC SANITARY TOWEL BAG WITH NEW BIODEGRADABLE VERSION



- White HDPE plastic bag for sanitary towels
- Ref. 799003 in PBAT (polybutylene adipthalate terephthalate)
- **Ref. 799003 certified 100% biodegradable**
- 25 bags per package
- 48 packages per carton (= 1200 bags)



Plastic sanitary towel bag	799002
Biodegradables PBAT sanitary towel bag	799003

SANILADY

ANTIMICROBIAL SCENTED BAGS

30 L ▶

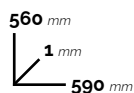

- Heavy duty liners, made from plastic
- Incorporates antimicrobial technology, SGS certified
- Protection against harmful germs (Staphylococcus aureus)
- Open bag dim. (LxH): 59x56 cm
- 10 rolls/pack, each includes 25 liners

10 rolls x 25 liners



Antimicrobial bags	130202
--------------------	---------------

SACCHETTI

PAPER SANITARY TOWEL BAG

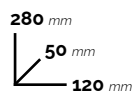

- Paper bags for sanitary towels
- Size: 12x28 cm
- 200 bags per package
- 10 packets per carton
- Responsible/sustainable forest management



Paper sanitary towel bag	99096
--------------------------	--------------

CARTA

TOILET SEAT COVER

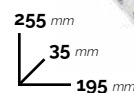

- **Bio toilet seat cover paper (14 gr or 18 g)**
- 200 sheets per pack
- Ref. 109114 sold 25 packs per carton
- Cod. 109118 sold 10 packs per carton



Toilet seat cover 14 gr	109114
Toilet seat cover 18 gr	109118

HYGIENE

**ENVIRONMENTAL
CARE**







AIR FRESHENERS

MAKE YOUR SPACE UNIQUE WITH THE RIGHT SCENT

Medial scent diffusers are an **elegant and sophisticated** way to create a unique and **welcoming atmosphere** in rooms. They are designed to release a constant, gentle fragrance.

The ranges dedicated to room scenting (**SOFFIO and BASICA**) have been expanded with devices such as **EXPLOSION atomisation technology**. An **innovative way to diffuse distinctive fragrances and create special olfactory atmospheres** in small-medium-large spaces.

The diffusers in the **EXPLOSION range** ensure a more **homogeneous and long-lasting fragrance** by **exploiting a sophisticated micronising technology** that converts the liquid fragrance into an extremely fine and impalpable cloud of perfume.

The Wi-Fi version, available with an elegant black casing, allows easy management of the device even remotely. In fact, the built-in connection module allows fast and absolutely customized programming.

EXPLOSION also extends the offer to **liquid fragrances**: soothing the room with the aroma of Green Tea, refreshing it with the breeze of Ocean Water and sweetening it with the **new Vanilla fragrance!**

From the skilful work of our expert perfumers, the **Malia range** was born several years ago and has expanded over time. It is a **professional line of highly concentrated, long-lasting air fresheners**. Twelve distinct quality fragrances, innovatively formulated to enhance the atmosphere in dedicated spaces, creating memorable olfactory experiences.



EXPLOSION 80

FRAGRANCE DIFFUSER FOR ATOMISATION

Wall-mounted - on stand version



220 mm
93 mm
106 mm

Colors available:



- Black or white plastic material (PP)
- Coverage area: 100 m³ (about 35 m²)
- LCD screen
- Silent operation low noise reduction (< 50 dBa)
- Use 3 pcs of "C" battery or USB 5V cable (both not included)
- Bottle capacity 100 ml
- Freestanding or wall holder (fixing kit included)
- Smart program controller:
 - 6 events control; 24 Hour setting system (ON/OFF);
 - smell concentration control
- Wide choice of "Explosion parfume" fragrances



AVAILABLE IN AR ON MEDIAL APP



Fragrance diffuser - White PP

117010

Fragrance diffuser - Black PP

117011

EXPLOSION 100

FRAGRANCE DIFFUSER FOR ATOMISATION



230 mm
86 mm
170 mm

VERSION



Colors available:



- White ABS shell (Wi-Fi version also available in black color)
- Sophisticated fragrance atomisation technology
- Digital programming display (LCD)
- Effective in room sizes up to 300 m³ (about 100 m²)
- Internal 200 ml plastic tank
- 4 programming scenarios - Choice of activation (17 options available)
- Choice of the activation/pause atomisation periods (5-300 sec.)
- Noise level: <50 dBa
- Operated by 12 V AC adapter (included)
- Freestanding or wall holder (fixing kit included)
- Wi-Fi version allows remote programming via smartphone/tablet
- Wide choice of "Explosion parfume" fragrances



AVAILABLE IN AR ON MEDIAL APP



Fragrance diffuser - White ABS

117000

WiFi fragrance diffuser - White ABS

117001

WiFi fragrance diffuser - Black ABS

117021



Dispensing point

Opening

Power supply socket

EXPLOSION 200

FRAGRANCE DIFFUSER FOR ATOMISATION



290 mm
113 mm
113 mm

Colors available:



- Black or silver anodized aluminium housing
- Coverage area: 200 m³ (about 70 m²)
- LCD screen
- Silent operation low noise reduction
- Power supply DC 12 V (included)
- Bottle capacity 60 ml
- Freestanding
- Smart program controller
 - 4 events control; 24 Hour setting system;
 - smell concentration control
- Wide choice of "Explosion perfume" fragrances



Dispensing point

AVAILABLE IN AR ON MEDIAL APP 

Fragrance diffuser - Black	117131
Fragrance diffuser - Silver	117132



EXPLOSION 1500

FRAGRANCE DIFFUSER FOR ATOMISATION



Colors available:



- Black or silver anodized aluminium housing
- Coverage area: 1000 m3
- Remote control
- Silent operation low noise reduction
- Power supply DC 12 V (included)
- Bottle capacity 500 ml
- Freestanding
- Smart program controller
 - 4 events control; 24 Hour setting system;
 - smell concentration control
- Wide choice of "Explosion parfume" fragrances



AVAILABLE IN AR ON MEDIAL APP



530 mm
195 mm
195 mm

Fragrance diffuser - Black	117111
Fragrance diffuser - Silver	117112

EXPLOSION 3000

FRAGRANCE DIFFUSER FOR ATOMISATION



Colors available:



TUTORIAL



- Black or silver anodized aluminium housing
- Coverage area: 3000 m3
- Smart App exclusively control Wi-Fi
- Silent operation low noise reduction
- Power supply DC 12 V (included)
- 1 L plastic Bottle
- Freestanding
- Smart program controller
 - 4 events control; 24 Hour setting system;
 - smell concentration control
- Wide choice of "Explosion parfume" fragrances



AVAILABLE IN AR ON MEDIAL APP



638 mm
195 mm
195 mm

Fragrance diffuser - Black	117121
Fragrance diffuser - Silver	117122

EXPLOSION PARFUME

LIQUID FRAGRANCE FOR FRAGRANCE DIFFUSER



- High quality propellant-free scent
- To be used with fragrance nebulizers and diffusers only
- Guarantees maximum fragrance's effectiveness
- Neutralizes bad smells
- Bottle of 250 ml (box of 4 pcs) or 1 L bottle (single)



Fragrances:



	250 ml	1 L
Explosion Parfume "Ocean Water"	86000527	86000523
Explosion Parfume "Green Tea"	86000627	86000623
Explosion Parfume "Relax"	86001527	86001523
NEW - Explosion Parfume "Vanilla"	86002027	86002023

EXPLOSION IGIENE AMBIENTE

LIQUID PERFUMER WITH HYGIENIZER FOR AUTOMATIC NEBULIZER



- Perfumer, with hygienizer and propellants free
- Alcohol-based perfumer formula with quaternary ammonium salts
- Perfumes, cleans the air and neutralizes bad smells.
- For large environments
- 250 ml bottle (4 pack) or 1 L bottle (single pack)



Fragrance:



	250 ml	1 L
Explosion Igiene Ambiente	86001627	86001623



Explosion Mixed 250 ml refills

86001727

BASICA

AUTOMATIC AIR FRESHENER

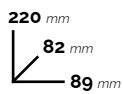

- White PP (polypropylene)
- Compatible with 250/270 ml refills
- LED indicators
- Adjustable 24H/day/night operation
- Adjustable activation frequency (7,5 / 15 / 30 min)
- Possibility of adjusting operating times and intervals
- Power supply: 2 x C LR14 - 1.5 V alkaline batteries (not included)



Inner control panel



Plastic lock

Automatic air freshener

104060

BASICA

DIGITAL AIR FRESHENER

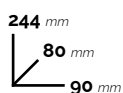

- White ABS cover and grey back
- Spray diffusion
- Compatible with 250/270 ml refills
- Digital programming display (LCD)
- Power supply: 2 x D LR20 - 1.5 V alkaline batteries (not included)
- Possibility of adjusting operating times and intervals
- Indicator light for battery charge control



Inner control panel



Plastic lock

Automatic air freshener

104062

SOFFIO

AUTOMATIC AIR FRESHENER



215 mm
85 mm
93 mm

- White PP (polypropylene)
- Spray diffusion
- Compatible with 250/270 ml refills
- LED indicators
- Adjustable 24H/day/night operation
- Adjustable activation frequency (7,5 / 15 / 30 min)
- Possibility of adjusting operating times and intervals
- Power supply: 2 x C LR14 - 1.5 V alkaline batteries (not included)



Dispensing hole



Inner control panel

Automatic air freshener

110540

SOFFIO

AUTOMATIC AIR FRESHENER



240 mm
85 mm
82 mm

- White ABS cover and grey back
- Spray diffusion
- Compatible with 250/270 ml refills
- Digital programming display (LCD)
- Power supply: 2 x D LR20 - 1.5 V alkaline batteries (not included)
- Possibility of adjusting operating times and intervals
- Indicator light for battery charge control



Dispensing hole

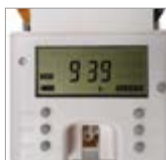

Inner control panel and LCD display

Automatic air freshener

110542

MALIA

SPRAY AIR FRESHENER REFILLS



250 ml ▼ "Classic" Scent concentration $\geq 1,2\%$



GREEN TEA



LOTUS FLOWER



MOJITO



BLACK ORCHID



TALC



VANILLA



COFFE FLOWER



VERVAIN

140 mm
65 mm

"Premium" Scent concentration $\geq 2\%$



VETIVER



SEA BREEZE

- Complex and long lasting fragrances
- High fragrance concentration leading a long-lasting scent effect
- Effective in room sizes up to 200 m³
- Fully compliant with aerosol legislation (SDS)
- Cans include 250 ml of fragrance (2.500 sprays - box of 12 pcs)



"Green Tea" CLASSIC scent	797010
"Lotus flower" CLASSIC scent	797011
"Mojito" CLASSIC scent	797012
"Black Orchid" CLASSIC scent	797013
"Talc" CLASSIC scent	797014
"Vanilla" CLASSIC scent	797015

"Coffee Flower" CLASSIC scent	797020
"Vervain" CLASSIC scent	797021
"Sea Breeze" PREMIUM scent	797016
"Vetiver" PREMIUM scent	797017
Mixed "Classic" scents	797019

MALIA IGIENE AMBIENTE

PERFUMED HYGIENIZER FOR ENVIRONMENTS



250 ml ▶



EUCALYPTUS



140 mm
65 mm



- Alcohol-based aerosol formula with quaternary ammonium salts
- It hygienizes all surfaces
- Perfumes and cleans the air, neutralizing bad smells
- Cans include 250 ml of fragrance (2.500 sprays - box of 12 pcs)
- Ready to use

Perfumed hygienizer for environments

797008

MALIA STOP

INSECT DETERRENT SPRAY



250 ml ▶



LEMONGRASS



140 mm
65 mm



- Formulation based on citronella and tea tree essential oils
- Provides a pleasant scent to the environment
- Creates an olfactory barrier that keeps insects away
- Compliant with current regulations on aerosol products (SDS)
- Fit in most dispenser on the market
- Cans include 250 ml of fragrance (2.500 sprays - box of 12 pcs)
- Ready to use

Insect deterrent spray

797004





VICISAN

HYGIENIZER DISPENSER FOR TOILETS/URINALS

Vicisan was created with the desire to build an increasingly **hygienic and healthy** environment in public spaces. It is a range of dispensers-automatic and mechanically operated-for the constant **hygiene of public toilets and urinals**. It features a **waterproof design** that provides an increased barrier against moisture and chemical corrosion. It is designed with the intention of maintaining **freshness and cleanliness** through fragrances that **neutralize odors**.



VICISAN

AUTOMATIC HYGIENIZER DISPENSER FOR TOILETS/URINALS

400 ml ▶



230 mm
72 mm
110 mm

- Polypropylene material, eco-friendly and good at chemical resistance
- Waterproof design to avoid humidity or chemical corruption
- Programmable LCD display
- Screw pump for recharging
- Refill capacity 400 ml maximum, dosage 0.12ml/per spray
- Working with 2 cells AA size alkaline batteries (LR6)



Battery compartment



Control Panel & LCD display



Reservoir

Automatic hygienizer dispenser for toilets/urinals

111101

VICISAN

MECHANICAL DISPENSER OF HYGIENIZER FOR TOILETS/URINALS

500 ml ▶



230 mm
72 mm
110 mm

- Polypropylene material, eco-friendly and good at chemical resistance
- Waterproof design to avoid humidity or chemical corruption
- Reservoir inside working with an absorbent wick, guiding liquid to drip by itself
- Refill capacity 500 ml maximum



Absorbent wick



Reservoir

Mechanical dispenser of hygienizer for toilets/urinals

111100

VICISAN

HYGIENIZER FOR TOILETS/URINALS



1 L ▶



- It hygienizes and perfumes the toilet every water discharge
- Leaves a protective film
- Keeps the toilet clean and fragrant
- 1 L bottle (9 units per box)

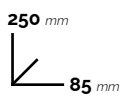

Hygienizer for toilets/urinals 1 L

20800224

URINAL NET

URINAL SCREEN



TROPICAL

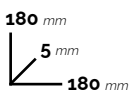

ORANGE & CINNAMON

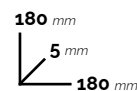

- Anti-splash urinal screen made from polyethylene
- Keeps urinals smelling fresh for up to 30 days
- Releases scent consistently over time
- Avoids pipe clogs
- Sold in 2 pieces sealed bags



Urinal Net Tropical

83000399

Urinal Net Orange Cinnamon

83000499

AIR HYGIENE

ONE SHOT AEROSOL FOGGER



150 ml ▶



145 mm
50 mm

- Alcohol-based aerosol formulation with quaternary ammonium salts
- Disposable self-emptying can with total release trigger (150 ml)
- Ensures a deep cleaning action on all sort of surfaces
- Purifies and refreshes the air, by neutralizing bad smells
- Works in 15-20 minutes, it's effective in rooms up to 60 m²/180 m³
- Professional application in several types of environments
- Great for treating offices, ambulances, doctors' offices, schools, etc.



One-shot trigger, total release gun

One shot aerosol fogger- 150 ml

797000

PROHYGIENE DRY

DRY SPRAY WITH DEEP CLEANING ACTION



400 ml ▶



200 mm
65 mm

- Multi-purpose cleaner containing alcohol and quaternary ammonium salts
- Can be used on a variety of surfaces and fabrics
- Dry formulation, it does not wet or grease
- Deep deodorization action, ideal to neutralize bad smells
- Effective, quick and ready-to-use
- Professional application in several types of environments
- Suitable in offices, waiting rooms, domestic environments, bus cabins, etc.



Spot spraying gun

Dry spray with deep cleaning action - 400 ml

797001



FLYING INSECT KILLERS

Medial's offering of flying insect killers was **expanded and improved** with products with more modern and minimalist shapes **in line with the new European standards**. In September 2021, the new European regulation for lamps and light sources came into force, setting out the eco-design requirements of the Single Lighting Regulation. This regulation specifies a minimum performance threshold for light sources and leads to the phasing out of non-compliant conventional lighting technologies. This regulation was accompanied by a second one that recalibrated the energy efficiency class scale (from A to G)..

The use of the **LED lamps** you will find in the Medial catalogue, which are **equipped with the manufacturer's exclusive and patented technology**, makes it possible to **halve electricity consumption compared to traditional actinic lighting**.

The high level of technology of the LED lamps in this catalogue makes it possible to safely replace old technology:

- **maintaining the usual lighting level**
- **achieving enormous energy savings**
- **considerably prolonging the life of the lamp**

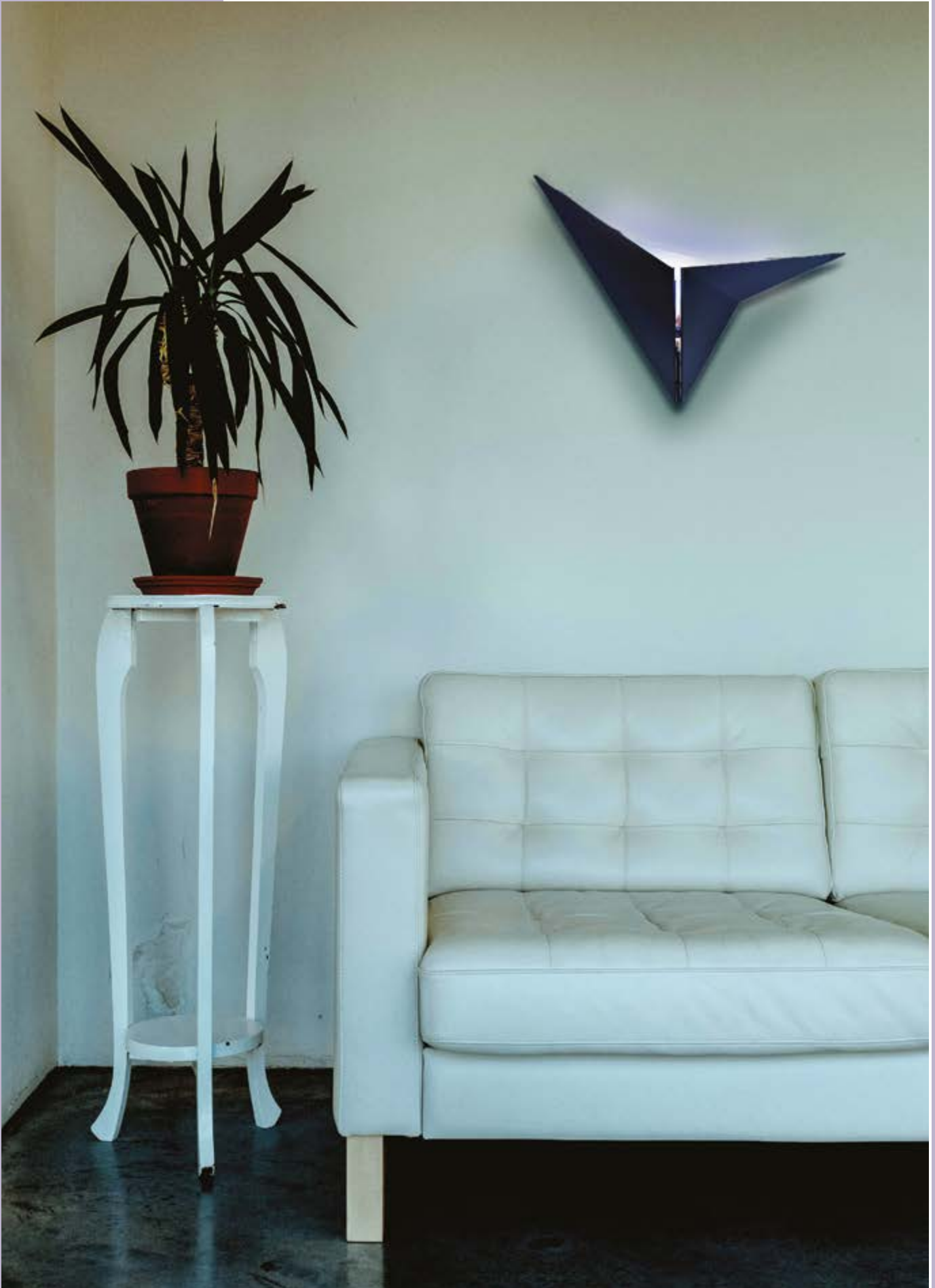

STARTRAP



DECORATIVE FLYING INSECT KILLER WITH GLUE BOARD



- 1x 5 W (E14)
- 50 m²
- 5 W max
- 2 Kg
- 220 V / 50 Hz

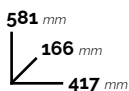

Colors available:



- White or black coated steel casing
- Power supply: 220 V - 50 Hz
- LED lamp 5 W (E 14)
- Coverage area up to 50 m²
- Equipped with glue board
- To be installed at 1,80 - 2,20 m from the floor
- Protection class: IP20



SPARE PARTS REFERENCES (TABLE ON PAGE 234)

Decorative flying insect killer 5 W LED - white	903143
Decorative flying insect killer 5 W LED - black	903141

APPLIQUE

DECORATIVE FLYING INSECT KILLER WITH GLUE BOARD

- 1x 5 W (E14)
- 80 m²
- 5 W max
- 2 Kg
- 220 V / 50 Hz



- 2x5 W (E14)
- 120 m²
- 10 W max
- 2,7 Kg
- 220 V / 50 Hz

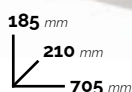

- White coated steel casing
- Power supply: 220 V - 50 Hz
- LED lamps 5 W each (E 14)
- Coverage area up to 80 m² or 120 m²
- Equipped with glue board
- To be installed at 1,80 - 2,20 m from the floor
- Ideal as decorative accessory
- Protection class: IP20



SPARE PARTS REFERENCES (TABLE ON PAGE 234)

Decorative flying insect killer 5 W LED	903107
Decorative flying insect killer 10 W LED	903108

IGLU

DECORATIVE FLYING INSECT KILLER WITH GLUE BOARD

-  1x 5 W (E14)
-  50 m²
-  5 W max
-  1.2 Kg
-  220 V / 50 Hz

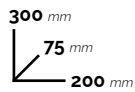

Colors available:



- Brushed s.steel or powder epoxy coated casing
- Power supply: 220 V - 50 Hz
- LED lamp 5 W (E 14)
- Coverage area up to 50 m²
- Equipped with glue board
- Wall-mounted (H 1.80/2.20 m) or on stand
- Quiet and odorless
- Protection class: IP20



 **SPARE PARTS REFERENCES (TABLE ON PAGE 234)**

Decorative flying insect killer 5 W LED - brushed s.steel	903130
Decorative flying insect killer 5 W LED - black	903131
Decorative flying insect killer 5 W LED - white	903133



INSETTIVOR LED

FLYING INSECT KILLER WITH ELECTRIC GRID

Colors available:



-  1x 5 W (E14)
-  50 m²
-  5 W max
-  3 Kg
-  220 V / 50 Hz

 260 mm
 125 mm
 265 mm



-  2x 5 W (E14)
-  120 m²
-  10 W max
-  3,6 Kg
-  220 V / 50 Hz



 260 mm
 125 mm
 330 mm

- Brushed stainless steel or white coated steel
- Power supply: 220 V - 50 Hz
- LED lamps 5 W each (E 14)
- Lamp life: 5,000 hrs approximately
- Coverage area: up to 50 m² or 120 m²
- Equipped with electric grid (3.000 V)
- Wall mounted, ceiling suspended or free standing
- Fixing kit and chain included
- Protection class: IP20







 **SPARE PARTS REFERENCES (TABLE ON PAGE 234)**

Flying insect killer with electric grid 5 W LED - s.steel/grey	903171
Flying insect killer with electric grid 5 W LED - white/grey	903172
Flying insect killer with electric grid 10 W LED - s.steel/grey	903173
Flying insect killer with electric grid 10 W LED - white/grey	903174

INSETTIVOR TUBE LED

FLYING INSECT KILLER WITH GLUE BOARD



-  2x 7 W (43 cm neon)
-  180 m²
-  14 W max
-  4,6 Kg
-  220 V / 50 Hz

 300 mm
 160 mm
 510 mm

- Brushed stainless steel casing
- Power supply: 220 V - 50 Hz
- LED lamps 7 W each (E 14)
- Coverage area up to 180 m²
- Equipped with glue board
- Wall mounted, ceiling suspended or free standing
- Fixing kit and chain included
- Protection class: IP20







 **SPARE PARTS REFERENCES (TABLE ON PAGE 234)**

Flying insect killer with electric grid 14 W LED **903109**

INSETTIVOR TRAP

FLYING INSECT KILLER WITH GLUE BOARD FOR INTENSIVE USE

-  2x 7 W (E14)
-  180 m²
-  14 W max
-  3,2 Kg
-  220 V / 50 Hz

160 mm
355 mm
465 mm

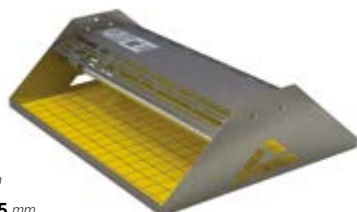

-  2x 9 W (E14)
-  240 m²
-  18 W max
-  5 Kg
-  220 V / 50 Hz

160 mm
355 mm
620 mm

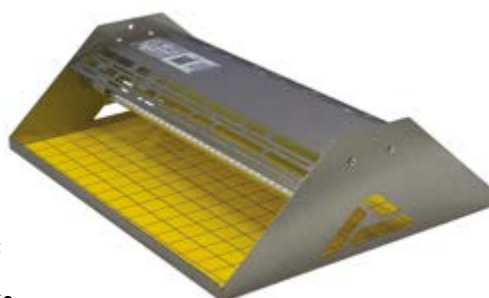

- AISI 304 brushed stainless steel casing
- Power supply: 220 V - 50 Hz
- LED lamps 7 W or 9 W (E 14) (14 or 18 W each)
- Coverage area up to 180 m² or 240 m²
- Equipped with glue board
- Wall mounted or ceiling suspended (kit included)
- Chain and bracket included
- Ideal for food and agricultural industry
- Protection class: IP20



 **SPARE PARTS REFERENCES (TABLE ON PAGE 234)**

Flying insect killer- 14 W (E14)	903181
Flying insect killer- 18 W (E14)	903182

INSECTIVORO

FLYING INSECT KILLER FOR MEDIUM ENVIRONMENTS



-  1x32 W (E14)
-  14-16 m
-  55 W max
-  2,4 Kg
-  230 V / 50 Hz

340 mm
220 mm
245 mm



- Grey polycarbonate and ABS casing
- Power supply: 230 V - 50 Hz
- 32 W lamp as a spare part
- Coverage area up to linear 14-16 m
- 1 speed silence motor
- Perfect for catering
- Large insect recovery drawer
- Protection class: II



 **SPARE PARTS REFERENCES (TABLE ON PAGE 234)**











Grey PC and ABS flying insect killer

703101

INSECT KILLERS SPARE PARTS



	 LED LAMP NEW GENERATION	OLD GENERATION LAMPS Compatible with previous versions	GLUE BOARDS
STARTRAP 	LED Lamp 5 W <hr/> 903157	X	Glue boards <hr/> 903094
APPLIQUE 	LED Lamp 5 W <hr/> 903157	FLUO Lamp 20 W (E 14) <hr/> 903057	Glue boards 180x465 mm <hr/> 903047 Glue boards 205x785 mm <hr/> 903045
IGLU 	LED Lamp 5 W <hr/> 903157	FLUO Lamp 20 W <hr/> 903057	Glue boards 160x195 mm <hr/> 903093
INSETTIVOR LED 	LED Lamp 5 W <hr/> 903157	FLUO Lamp 20 W (E 14) <hr/> 903057	X
INSETTIVOR TUBE LED 	LED Lamp 7 W <hr/> 903153	NEON Lamp 15 W (43 cm) <hr/> 903053	Glue boards 195x460 mm <hr/> 903092
INSETTIVOR TRAP 	LED Lamp 7 W <hr/> 903188 LED Lamp 9 W <hr/> 903189	NEON Tube 15 W <hr/> 903088 NEON Tube 36 W <hr/> 903089	Glue boards 363x456 mm <hr/> 903048 Glue boards 364x598 mm <hr/> 903049
INSECTIVORO 	X	Lamp 32 W <hr/> 703151	X

STERY KS

UVC-RAY KNIFE STERILIZER CABINETS

 **Slotted holder**

 12 knives



607 mm
145 mm
346 mm

 20 knives



607 mm
145 mm
496 mm

- AISI 304 stainless steel casing
- Power supply: 220 V - 50 Hz
- Smoked plexiglass doors with magnetic lock
- 15 W UVC (253 nm) lamp (to be replaced once a year)
- Slotted holder for 12 or 20 knives
- Automatic pre-programmed timer (2h)
- Activation of sterilisation when the door is closed
- Green light in operation; red at the end of the sterilization cycle
- 99.99% germicide action after a minimum cycle of 110 minutes
- Product tested in laboratory by Microsept
- Protection class IPX4



UVC-rays sterilizer w/slotted holder 12 knives	903024
UVC-ray sterilizer w/slotted holder 20 knives	903025
UVC lamp	903054

STERY

UVC-RAY KNIFE STERILIZER CABINETS

 **Slotted holder**

 10 knives



595 mm
145 mm
370 mm

 20 knives



593 mm
145 mm
525 mm

 **Magnetic**

 10 knives



593 mm
145 mm
525 mm

 20 knives



593 mm
145 mm
939 mm

- Brushed AISI 441 stainless steel casing
- Power supply: 220 V - 50 Hz
- Smoked plexiglass doors with magnetic lock
- 15 W UVC (253 nm) lamp (to be replaced once a year)
- Slotted holder or magnetic bar
- Adjustable timer from 0 to 120 minutes
- Two sizes available (10 or 20 knives)
- 99.99% germicide action after a minimum cycle of 90 minutes
- Product tested in laboratory by Microsept
- Protection class IP20



Sterilizer with slotted holder for 10 knives	903021
Sterilizer with slotted holder for 20 knives	903022
Sterilizer with magnetic holder for 10 knives	903032
Sterilizer with magnetic holder for 20 knives	903033
UVC lamp	903054

TOTEM PRESS

FOOT-OPERATED SANITIZING STATION



Colors available:



- Hands-free station made from polyester coated steel
- Features an adjustable bottle tray with upper holder
- Compartment to storage a tissue, glove, mask box
- Slightly push the pedal down to get a sanitizing dose on the hands
- Ideal solution to reduce the risk of cross-contamination
- Pre-assembled, with stickers included



1415 mm
365 mm
300 mm

Pedal-operated sanitizing station - Black

789151

Pedal-operated sanitizing station - White

789153

TOTEM EVOLUTION

FREESTANDING SANITIZING STATION



Built-in plate



Telescopic system



1350 mm
450 mm
520 mm

- Freestanding station made from black coated steel
- Holds an automatic hand gel dispenser
- Vandal-proof build-in shield to protect the floor
- Comes with a header (14x14 cm) to apply visible signage
- Equipped with a telescopic system to adjust its height
- Star-shaped base for enhanced stability



Freestanding sanitizing station

779052

TOTEM HIGGY

FREESTANDING SANITIZING STATION

- Black coated steel freestanding station
- Holds an automatic hand gel dispenser
- Vandal-proof build-in shield to protect the floor
- Comes with a header (14x14 cm) to apply visible signage
- Equipped with a telescopic system to adjust its height



1400 mm
318 mm
318 mm



Freestanding sanitizing station

160750

NEBULA

ALCOHOL LIQUID HAND RUB ATOMIZER

0,7 L ▶



230 mm
60/100 mm
230 mm

- Heavy-duty ABS backing and cover
- Refillable tank 700 ml
- For alcohol-based liquid cleaner
- Automatic infrared sensor operated
- Adjustable dispensing time (4,5,7 or 9 sec.)
- Adjustable spray delivery (0,4/0,5/0,8/1,1 ml)
- AC Adapter or battery powered (4 AA x 1,5 V) not included
- Freestanding, post fixation, wall-mount installation



Alcohol liquid hand rub atomizer 0,7 L

113000

AC adapter for NEBULA automatic dispenser

104950

TOTEM EVOLUTION

COUNTERTOP AND WALL-MOUNT HAND SANITIZER HOLDER



248 mm
205 mm
155 mm

220 mm
80 mm
115 mm

- Black coated metal holder
- Top opening holds a diameter bottle 27 mm



Countertop hand sanitizer holder

779053

Wall-mount hand sanitizer holder

779055

FREESTANDING SANITIZING STATION ACCESSORIES

Hand gel bottle holder

Double PPE compartment holder

Swing waste bin holder



30 mm
95 mm
115 mm

80 mm
250 mm
465 mm

148 mm
65 mm
187 mm

- Black coated steel
- Black polypropylene plastic bin



Hand gel bottle holder

779051

Double PPE compartment holder

779056

Swing waste bin holder

779057

COMPLETE THE RANGE WITH:

RIF BASIC

SWING WASTE BIN

Page 44

35 L ▶



Ref. 909536

FURNISHING ACCESSORIES

This category represents our **growth area** and will be replenished over the years with the aim of having an **increasingly specialist catalogue in the generalist sphere**.

The products presented represent **quality décor and equipment solutions for cosy offices and professional spaces that combine functionality and style**.

The great novelty of entrance mats provides an extended range of furnishing accessories that not only contribute to the decorum, safety and cleanliness of the environment, but also enriches our product portfolio with certifications related to eco-sustainability.

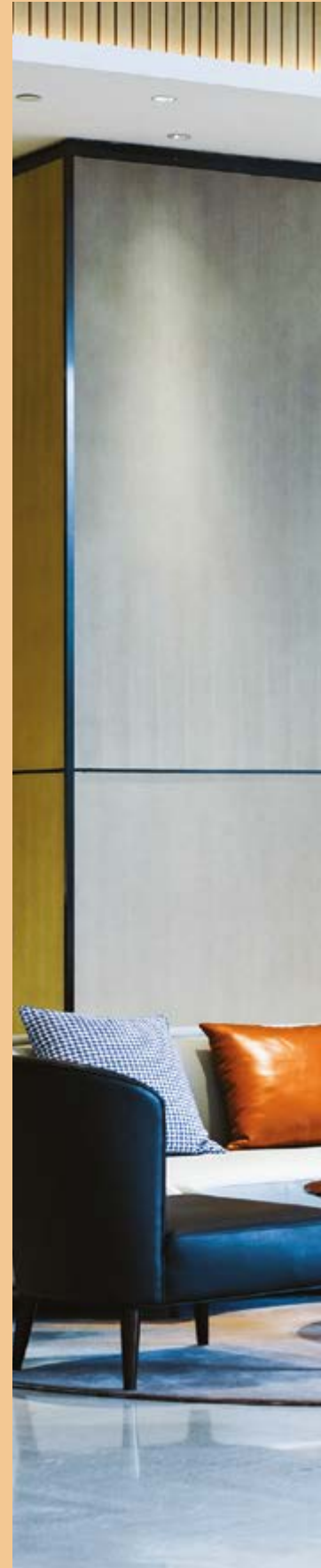





FURNISHING ACCESSORIES

ENTRANCE MATS	P. 244
CROWD CONTROL POSTS	P. 250
UMBRELLA STANDS	P. 254
COAT STANDS	P. 256
RECEPTION SEATINGS	P. 258
PICTOGRAMS	P. 259







ENTRANCE MATS

An entrance mat is a simple but effective way to **protect floors** from dirt, moisture and wear, helping to extend the time between cleanings. It also increases safety by preventing slips and falls on wet and slippery surfaces. By keeping dust and debris at the door, it **keeps the building clean and well maintained every day.**

PRODUCT CATEGORIES

Categories A and B represent scraping carpets, optimized for dirt absorption. These are indoor carpets that do not need to be combined with outdoor carpets. The quality of the Aqua brand - developed by 3M - thanks to the unique Twin fibre design allows it to work for both dirt and moisture absorption. **Categories C and D** are carpets made of soft materials, optimised for moisture absorption. For maximum performance in these categories, a combination with outdoor carpets might be suggested. **Category E** is intended for outdoor use and due to its characteristics, captures dirt and drains water.

	HIGH TRAFFIC 	MEDIUM/LOW TRAFFIC 
DO NOT COMBINE WITH OUTDOOR MATTING (SCRAPING)	A	B
TO BE COMBINED WITH OUTDOOR MATTING (ABSORBING)	C	D
OUTDOOR MATTING	E	



A Medial booklet has been created to represent the extensive range of mat qualities in our assortment accompanied by their main features

Mats Booklet

930999

AQUA 85

HIGH TRAFFIC ENTRANCE MATS

Dimensions and colours available:

- 90 x 150 cm
- 130 x 200 cm
- 130 x 600 cm

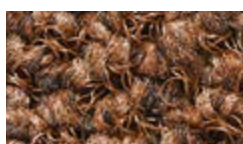
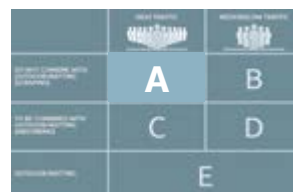

- Suitable for HIGH traffic volumes (1500 to 5000 daily steps)
- Made of ECONYL® with unique double-fibre structure
- Advanced water removal and retention characteristics
- Yarn arranged as a mixed pattern to hide more soil
- Cfl-s1 certificate for hardly inflammable goods
- Phthalate-free, slip-resistant PVC backing
- Excellent durability and appearance retention
- Easy to clean
- Available in different colours and sizes



ECONYL®
Made with 100% regenerated nylon



	BLACK	GREY	BROWN	BLUE	RED
AQUA 85 mat - 90 x 150 cm	930211	930212	930219	930215	930217
AQUA 85 mat - 130 x 200 cm	930221	930222	930229	930225	930227
AQUA 85 mat - 130 x 600 cm	930231	930232			

AQUA 65

MEDIUM TRAFFIC ENTRANCE MATS

Dimensions and colours available:

- 60 x 90 cm
- 90 x 150 cm
- 130 x 200 cm

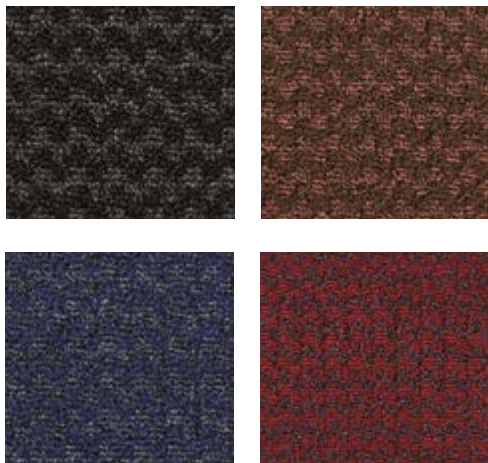

- Suitable for MEDIUM traffic volumes (500 to 1500 daily steps)
- Dual-fibre loop pile, arranged in a checked pattern
- Polypropylene thin fibres + polyamide 6 thick fibres
- Nonwoven PET/PA base
- Phthalate-free, slip-resistant PVC backing
- Superior fine dirt and moisture removal
- Excellent appearance retention
- Long lasting and Easy to clean
- Available in different colours and sizes



	BLACK	BROWN	BLUE	RED
AQUA 65 mat - 60 x 90 cm	930101	930109	930105	930107
AQUA 65 mat - 90 x 150 cm	930111	930119	930115	930117
AQUA 65 mat - 130 x 200 cm	930121	930129	930125	930127

AQUA 45

LOW TRAFFIC ENTRANCE MATS

Dimensions and colours available:

- 60 x 90 cm
- 90 x 150 cm

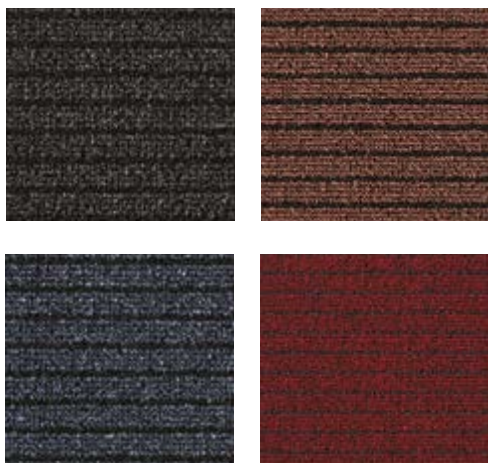

- Suitable for LOW traffic volumes (up to 500 daily steps)
- Dual-fibre loop pile, arranged in a striped pattern
- Polypropylene thin fibres + polyamide 6 thick fibres
- Nonwoven base of polyester and polyamide 6
- Phthalate-free, slip-resistant PVC backing
- Excellent dirt removal and water absorption characteristics
- High safety for pedestrian traffic and trolley passage
- Long lasting and easy to clean
- Available in different colours and sizes



	ANTHRACITE	BROWN	BLUE	RED
AQUA 45 mat - 60 x 90 cm	930000	930009	930005	930007
AQUA 45 mat - 90 x 150 cm	930010	930019	930015	930017

DURATAP

MEDIUM TRAFFIC ENTRANCE MATS



Dimensions and colours available:

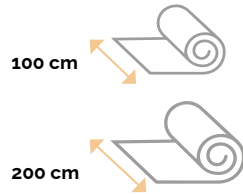

- Suitable for MEDIUM traffic volumes (500 to 1500 daily steps)
- The most wear-resistant coir mat
- High use class rating of 32 (commercial use)
- Fire protection class rating of Cfl -s1.
- Heavyduty, tightly tufteda
- Easy for wheelchairs and rollators
- This thick, firm coir mat has a stiff , bristly feel
- Custom-made carpets sold by metre linear



	HEAVY TRAFFIC	MEDIUM TRAFFIC
	A	B
	C	D
	E	

DURATAP Rolls - 100 cm CUT **934100**

DURATAP Rolls - 200 cm CUT **934200**



DELTA

HIGH TRAFFIC ENTRANCE MATS



Dimensions and colours available:

- 60 x 90 cm
- 90 x 150 cm
- 135 x 200 cm



- Suitable for MEDIUM traffic volumes (500 to 1500 daily steps)
- Made of ECONYL® or 100% regenerated nylon
- Saves more than 5 kg of CO2 emissions in production
- Contains HydroTX™ technology
- Absorbs moisture faster
- Keeps the floor inside under the carpet clean and dry
- Available in different colours and sizes



ECONYL®
Made with 100% regenerated nylon



	BLACK	GREY	TAUPE
<i>DELTA</i> mat - 60 x 90 cm	931001	931002	931004
<i>DELTA</i> mat - 90 x 150 cm	931011	931012	931014
<i>DELTA</i> mat - 135 x 200 cm	931061	931062	931064



NELSON



LOW TRAFFIC ENTRANCE MATS

Dimensions and colours available:

- 60 x 90 cm
- 90 x 150 cm



- Suitable for LOW traffic volumes (up to 500 daily steps)
- Made from solution dyed polyamide assuring a very long lifetime
- Phthalate-free PVC backing, impermeable for water
- Heathered design visually hides dust and debris
- Facilitates easy vacuum cleaning
- Does not fade in sunlight and withstands aggressive cleaning chemicals
- Available in different colours and sizes



60 x 90 cm	A	B
90 x 150 cm	C	D
90 x 150 cm	E	

	ANTHRACITE	GREY
NELSON mat - 60 x 90 cm	932000	932002
NELSON mat - 90 x 150 cm	932010	932012



COLLECT



HIGH TRAFFIC OUTDOOR ENTRANCE MATS

Dimensions and colours available:

60 x 90 cm
90 x 150 cm



- Suitable for HIGH traffic volumes (1500 to 5000 daily steps)
- Conceived for an external use
- Made of 100% polyamide yarns
- Very fine scraping loop pile absorbs dirt and moisture
- Aids water drainage
- Very strong and suit for commercial use
- Available in different colours and sizes



	ANTHRACITE	BROWN	RED
COLLECT mat - 60 x 90 cm	933000	933009	933007
COLLECT mat - 90 x 150 cm	933010	933019	933017



GAMMA

POSTS WITH ROPES



Colors available:



4 anchor points
Ring Ø 100 mm



Customizable top

- Stainless steel or golden s. steel
- Tube diameter: 50 mm
- Top with 4 openings for rope clip ends
- Compatible with information board
- Cement-lined base covered in galvanised steel

Polished s. steel post	116000
Golden s. steel post	116001

ROPE WITH 2 HOOKS



Colors available:



- Ropes for traditional posts
- 1.5 m long
- Rope diameter: 31 mm
- Golden or s. steel fixing hooks

Blue rope with s. steel ring hooks	116020
Blue rope with golden ring hooks	116030
Bordeaux rope with s. steel ring hooks	116021
Bordeaux rope with golden ring hooks	116031
Black rope with s. steel ring hooks	116022
Black rope with golden ring hooks	116032

GAMMA



CUSTOM-CUT ROPE



∅ 30 mm

- Rope for traditional posts
- Custom-cut length of rope
- Rope diameter: 31 mm
- Golden or s.steel fixing hooks

Colors available:



Blue rope	116040
Bordeaux rope	116041
Black rope	116042
S.steel ring hooks	116010
Golden ring hooks	116011

WALL MOUNTED RING FOR ROPES



45 mm
40 mm
48 mm

Colors available:



- Polished s. steel or golden s. steel

Polished stainless steel hook	116015
Golden stainless steel hook	116016

GAMMA BOARD



INFORMATION BOARD

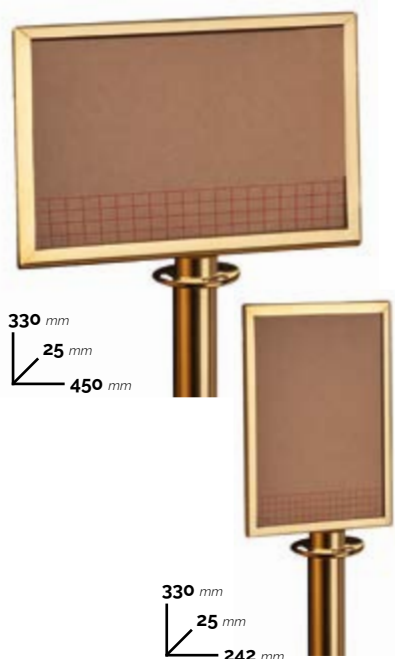

- Vertical board (A4 dim.) or horizontal (A3 dim.)
- S. steel frame, polished or golden finish
- Adaptors sold separately
- Unscrew the knob and screw on the panel with adapter

Colors available:

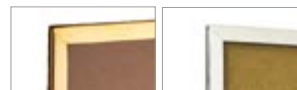

Vertical board (A4) polished s.steel frame	116060
Vertical board (A4) golden plated s.steel frame	116061
Horizontal board (A4) polished s.steel frame	116065
Horizontal board (A4) golden plated s.steel frame	116066
Adaptor polished s.steel frame	116070
Adaptor golden plated s.steel frame	116071

ALFA

RETRACTABLE BELT STANCHIONS



950 mm
360 mm

Colors available:



- Polished s.steel or coated steel
- Stanchion diameter: 63 mm
- Belt length: 2 m
- Weight of stainless steel posts: 8.4 kg
- Weight of metal posts: 8.7 Kg



	BLUE BELT	RED BELT	BLACK BELT
S. Steel station	103350	103351	103352
Black coated steel station	103340	103341	103342

ALFA MURAL

WALL MOUNTED RETRACTABLE BELT

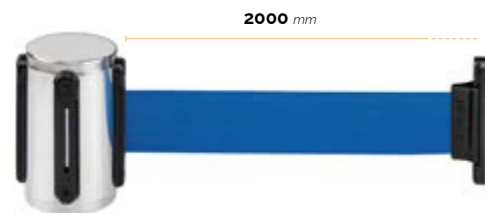

120 mm
60 mm

- Stainless steel or coated steel
- Wall mounted system with belt and plastic clip
- Belt length: 2 m
- Wall receptor included



Colors available:



Wall receptor

103987

	BLUE BELT	RED BELT
Wall mounted s.steel system	103390	103391
Wall mounted black steel system	103392	103393

ALFA BASIC

RETRACTABLE BELT STANCHIONS



- AISI 201 stainless steel base and column
- ABS mechanism
- Nylon belt length: 2 m
- Pole diameter: 60 mm
- Weight: 5.4 kg
- Reception on 3 sides



Colors available:



BLUE BELT	RED BELT	BLACK BELT
116050	116051	116052

S. Steel station

ALFA BOARD

INFORMATION BOARD



- Vertical board (A4 dimensions)
- Horizontal board (A3 dimensions - **only for ALFA BASIC model**)
- Adaptors sold separately



S.steel adaptor



ALFA BASIC

A4 (vertical) information board	116060
A3 (horizontal) information board	116065
Stainless steel adaptor	116072

PLUVIAL

UMBRELLA STAND



27 L ▶



600 mm
255 mm

- Polished stainless steel or coated steel body
- Plastic base to protect floor surface
- Removable inner plastic tray for water collection
- Dual purpose (umbrella stand or paper bin)



Colors available:

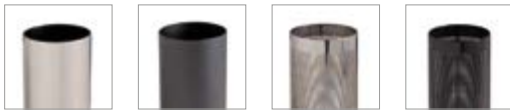

	S.STEEL	BLACK
Umbrella stand 27 L	775100	775101
Perforated umbrella stand 27 L	775110	775111

PLUVIO BASIC

UMBRELLA STAND



22 L ▶



500 mm
240 mm

Colors available:



- Polished stainless steel or powder epoxy coated steel body
- Dual purpose (umbrella stand or paper bin)
- Removable inner plastic tray for water collection



Umbrella stand polished s. steel 22 L	775120
Umbrella stand black coated steel 22 L	775121

PLUVIO PLASTIC

UMBRELLA STAND



25 L ▶



520 mm
250 mm

- Polypropylene body
- Heavy-duty and robust
- Dual purpose (umbrella stand or paper bin)



Umbrella stand black polypropylene 25 L	710008
---	--------

MULTI

UMBRELLA STAND



525 mm
260 mm
520 mm

- Powder-coated steel structure
- Plastic inner water tray
- Ideal for waiting rooms, shop entrance, offices, etc.

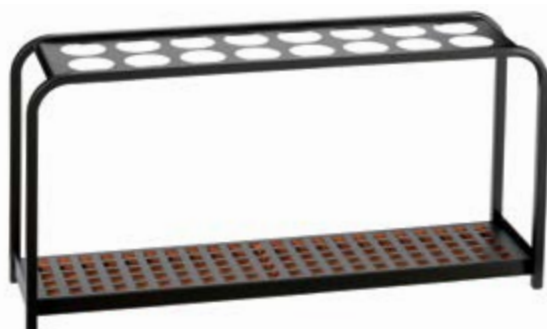

520 mm
260 mm
1002 mm

Umbrella stand black steel 8 holes

714019

Umbrella stand black steel 16 holes

714029

FURBY

AUTOMATIC UMBRELLA WRAPPER

Wrapping bags



740 mm
310 mm
205 mm



- Coated steel body in gray finish
- Battery-free mechanical operation, no electricity or other connection required
- Built-in carry handles
- Ideal solution to prevent floor from getting wet and slippery
- Compact and elegant design
- Capacity: 500 wrapping bags max



Wet umbrella wrapper

110570

Wrapping bags

110571

ELISA

WALL MOUNTED COAT STAND



- Powder epoxy coated steel
- Wall mounted coat stand (with 2, 3, 4 or 5 hooks)



Wall mounted coat stand Elisa 2 hooks **703012**

Wall mounted coat stand Elisa 3 hooks **703013**

Wall mounted coat stand Elisa 4 hooks **703014**

Wall mounted coat stand Elisa 5 hooks **703015**

COSTANCE

COAT STAND



- Structure and base in coated steel
- Rotating top
- 8 polypropylene hooks
- Metal base with rubber tips



Coat stand Costance **703001**



CHIARA

COAT STAND



1660 mm
450 mm

- Structure in coated steel
- Polypropylene base
- 8 polypropylene hooks
- Umbrella holder with drip tray



Coat stand Chiara

703004

GIORGIA

COAT STAND



1700 mm
400 mm

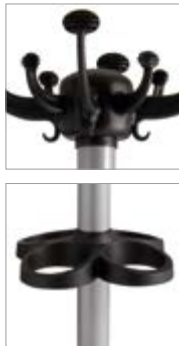

- Structure in coated steel
- Polypropylene base
- 8 polypropylene hooks
- Umbrella holder with trip tray



Coat stand Giorgia

703002

SOFIA

COAT STAND



1750 mm
390 mm



- Structure in coated steel
- Polypropylene base
- 8 polypropylene hooks
- Umbrella holder with trip tray



Coat stand Sofia

703003

PANCA

SEAT BENCH + TABLE



PANCA DUE

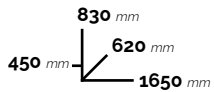

PANCA TRE

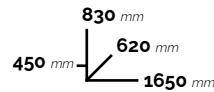

- Light grey powder epoxy coated steel structure
- Seats and table (PANCA DUE) perforated steel
- Bench can be fixed to the floor
- Ideal for waiting rooms: airports, train stations...



POSSIBILITY TO CUSTOMIZE PRODUCT CONFIGURATION

2-seat bench + table

703051

3-seat bench

703050

ON DEMAND:

Items only on request. Special productions. Timing to be evaluated



2-seat bench

703052

4-seat bench

703054

5-seat bench

703055

PITTONOIR

PICTOGRAMS



160 mm
120 mm

- Black coated steel
- 3D laser engraving
- Can be fixed with 2 strips of double-sided tape
- Customization of symbols on request



Black coated steel - INFORMATION	719910
Black coated steel - MAN	719911
Black coated steel - WOMAN	719912
Black coated steel - WC	719913
Black coated steel - WHEELCHAIR	719914
Black coated steel - MAN & WOMAN	719916
Black coated steel - NO SMOKING	719917
Black coated steel - NURSERY	719918
Black coated steel - Wi-Fi	719919



FOR PRODUCT CARE

GUIDE TO MATERIALS AND MAINTENANCE





MATERIALS, PROCESSING AND FINISHINGS GUIDE

This short guide describes the raw material features and the types of processing used in our products' manufacturing. We indeed believe that sale effectiveness depends on information sharing with customers, enabling people to take more conscious and critical purchasing decisions.

PLASTICS

ABS

ABS is a thermoplastic resin derived from acrylonitrile, butadiene and styrene polymerization. Besides being highly recyclable, ABS is also highly-resistant to impacts, scratching and abrasions. As for its chemical resistance, ABS withstands corrosion of substances, such as water, saline solutions, acids, alkaline solutions, saturated hydrocarbons (gasoline) and mineral oils. All these features make ABS the ideal material for our range of bathroom accessories and ensure a high level of hygiene and easy maintenance.



POLYETHYLENE (PE)

Polyethylene is a thermoplastic resin derived from ethylene polymerization. Polyethylene has good mechanical properties, resulting in high tensile, flexural, abrasion and impact strength. As for its chemical resistance, it is impermeable to water and it is resistant to corrosion by chemical agents, such as saline solutions, acids, alkali, alcohol and gasoline. It may be affected by oxidizing acids such as nitric, sulfuric and halogens acids. In addition to being highly recyclable, polyethylene offers a high weathering resistance that makes this material ideal for the production of outdoor waste bins and containers.



POLYPROPYLENE (PP)

Polypropylene is a thermoplastic derived from propylene polymerization. Due to its crystalline structure, this material is rigid yet lightweight. As for its mechanical properties, polypropylene is resistant to loads, tensile, impact and abrasion. Regarding to its chemical properties, this material is resistant to corrosion by saline aqueous solutions, weak acids, alkaline solutions, alcohol, certain oils and washing solutions, while it is not resistant to strong oxidizing and halogenated hydrocarbons agents.



FOR PRODUCT CARE

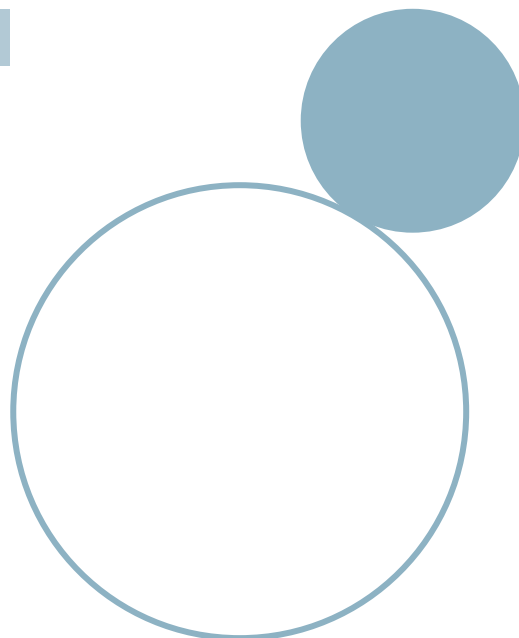

POLYMETHACRYLATE (PMMA)

Also known as Plexiglas®, the polymethacrylate is composed of methacrylate polymers. Particularly appreciated for its light weight, this material is also unbreakable. In fact, polymethacrylate has a good tensile, compressive and bending resistance. On the other hand, it is more sensitive to abrasion. Polymethacrylate is characterized by a great light transmission. Thanks to its technical properties, the polymethacrylate sheets are often used as an alternative to glass, especially for the production of mirrors, safety and accident prevention items.



POLYCARBONATE (PC)

Polycarbonate is a polymer obtained from the polycondensation of bisphenol A (BPA) and a carbonate or phosgene. It offers excellent mechanical properties. Polycarbonate characteristics are close to those of polymethylmethacrylate (PMMA, acrylic), with in addition a high temperature resistance. Polycarbonate offers very high transparency. Thanks to its excellent impact resistance, it is also used in the manufacture of motorcycle helmets and police shields.



EXTRUDED POLYSTYRENE (XPS)

Polystyrene is a thermoplastic polymer produced from styrene. It possesses a high impact and weathering resistance. It is also dyed and resists to UV, therefore this material is ideal for producing products for outdoor use.



MATERIALS, PROCESSING AND FINISHINGS GUIDE

METALS

STEEL

Steel is an alloy consisting mostly of iron, carbon and other elements. Its properties result from both chemical composition and manufacturing process. Despite being available in several qualities and grades, any type of steel has outstanding mechanical and chemical properties, such as strength, durability and resistance to both impacts and corrosion.



STAINLESS STEEL

"Stainless steel" is a collective term used to identify a special group of iron-based alloys, containing at least 1,2% carbon and 10,5% chromium, and other elements. Depending on the amount of the constituents in the alloy, stainless steel can be categorized in several families and subcategories. Medial International pays great attention in selecting the best stainless steels. We make use of the following stainless steel grades: AISI 201, AISI 304, AISI 430. Stainless steel is appreciated for its aesthetic qualities, as well as its strength, durability and eco-compatibility since it is 100% recyclable. But one of its most distinctive features concerns its corrosion-resistance. Stainless steel has indeed a unique self-healing property. By combining with Nickel and Molybdenum, Chrome forms a thin protective layer on surface with the assistance of Oxygen from air or water. If this thin layer is scratched, it immediately rebuilds, keeping protecting the surface from corrosion. However, the durability of stainless steel over time, whatever grades is concerned, is related to a regular maintenance and cleaning.



FOR PRODUCT CARE

CORROSION RESISTANCE	Stainless Steel		
	AISI 430	AISI 201	AISI 304
	Ferric	Austenitic	Austenitic
ENVIRONMENTS			
City environments	●	●	●
Moist environments	●	●	●
Salt water environments	●	●	●
SUBSTANCES			
Acetic acid (0-20%)	●	●	●
Pure acetone	●	●	●
Citric acid (5%)	●	●	●
Hydrochloric acid	●	●	●
Hydrofluoric acid	●	●	●
Lactic Acid	●	●	●
Muriatic acid	●	●	●
Sulfuric acid	●	●	●
Sulphurous acid	●	●	●
Carbon dioxide	●	●	●
Sulphur dioxide	●	●	●
Ammonia	●	●	●
Petrol	●	●	●
Baking soda	●	●	●
Sodium bisulfate	●	●	●
Bleach	●	●	●
Chloroform	●	●	●
Ferric & ferrous chloride	●	●	●
Ammonium & potassium chloride	●	●	●
Calcium & sodium hypochlorite	●	●	●
Vegetable oils (hot and cold)	●	●	●
Soap	●	●	●
Sulfates (aluminum-magnesium-ammonium)	●	●	●
Trichlorethylene	●	●	●

LEGEND:

- = Outstanding resistance
- = Good resistance
- = Limited resistance
- = Not recommended

* For further info, please consult the dedicated guides you'll find in "products" section on our website www.medialinternational.com

SURFACE TREATMENTS

GALVANIZATION

Galvanization is a process that involves the application of a zinc coating on a metal surface to prevent its oxidation. The most common process is hot-dip galvanization, which is carried out by immersing metal (iron or steel) in a bath of liquid zinc to produce a corrosion resistant, multi-layered coating of zinc-iron alloy and zinc metal. The coating forms an equal thickness on all surfaces immersed in the galvanizing kettle. This process provides a long-lasting, maintenance-free protection that slows the processes of corrosion and surface deterioration. If coating is damaged, leaving uncovered portions of the underlying material, the zinc coating acts as a sacrificial anode to avoid the formation of rust on the metal.

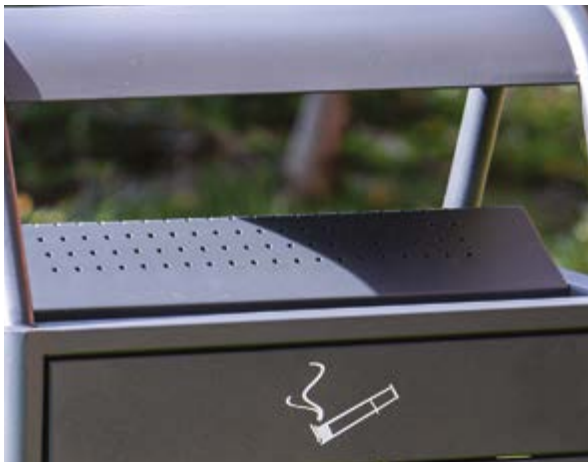

CATAPHORESIS

Cataphoresis is a painting technics that consists in immersing the part in a bath of water-soluble paint, connected to a cathode and by migrating particles of paint in suspension in the bath by means of an electric current of a certain tension, from the anode to the cathode. The paint particles are then applied evenly and over substantially the entire surface of the immersed part. Furthermore, the homogeneity of the coating provides good bonding layers and excellent corrosion resistance even to those areas which are hard to reach with traditional methods. If coating is damaged, leaving uncovered portions of the underlying material, the primary layer of painting acts to avoid the formation of rust on the metal. This treatment is indeed very suitable for varnishing products for outdoor use.

POWDER EPOXY COATING

Powder Epoxy Coating is a type of coating that consists in applying electro-statically dry powder and cured under heat to allow it to flow and form a hard thin layer. They have great mechanical strength and good resistance to corrosion by agents such as acids. Furthermore, the coating is hard and slightly opaque.



GENERAL SURFACE CLEANING AND MAINTENANCE*

PLASTIC

Plastic surfaces require periodic cleaning, which has to be carried out using a soft cloth soaked in warm water. If this operation is not effective, we suggest to use a dedicated cleaner for plastic parts. Pay attention to detergents containing solvents, as they may corrode and damage the material surface. As for cleaning and maintenance of polymethacrylate mirrors, we highly recommend to clean the surfaces using a specific detergents for methacrylate together with a non-abrasive cloth. Do not use paper to clean acrylic mirrors.

COATED STEEL

Cleaning is to be carried out periodically since this help keep unchanged the coating. If this is not effective, we suggest to use a mild cleaner. Pay attention to following substances as they can corrode and damage the coating: Aceton, Methylethylketon, Trichlorethan, Toluol, Trichlorethan, Xylol, hydratisierte Ammonium, Natrium-Hydrat.

STAINLESS STEEL

Proper and regular maintenance of metal products helps prevent surface oxidation, keeping the surfaces charm unchanged over time. Depending on the type of surface to maintain, we suggest to clean them periodically with a specific cleaner. As for stainless steel products, they need to be clean appropriately and periodically to remove dust, lime and dirt. As for daily cleaning operation, we suggest to clean stainless steel surfaces with a non-abrasive sponge and a mild solution, then rinse surface with warm water and wipe it with a smooth cloth. Out of ten/twenty routine cleaning operations, it is necessary to perform an extraordinary cleaning operation with a specific non-aggressive product, both creamy or spray. Several specific cleaners are also available on the market. For both ordinary and extraordinary cleaning operations, carbon steel brushes or steel wool should be avoided as they may leave particles embedded on the surface, leading to oxydation.



DISPENSERS CLEANING AND MAINTENANCE

In order to function properly, dispensers must be used with a quality cleaner and must be maintained periodically. Below, you will find some quick and practical tips to keep the product always working and in an excellent condition.

CLEAN THE DISPENSER COVER

Dispensers, especially stainless steel ones, look better over time if the outer shell is cleaned regularly. This prevents the formation of stubborn stains or oxidation points.

For **routine cleaning** it is enough to:

- Apply a mild detergent to the affected areas and rub the surface with a slightly damp cloth. In the case of satin-finished stainless steel dispensers, it is advisable to perform the operation in the direction of the satin finish;
- Rinse with warm water to remove dirt, stains or soap residues, and then dry gently with a soft absorbent cloth;
- Repeat the operation daily (or more often) depending on the severity of the product to be treated.

For **extraordinary cleaning** of the cover, you can:

- Use a 1% ammonia solution, but be careful not to return the solution too strong. Alternatively, it is possible to use a specific detergent for the type of surface treat (plastic or stainless steel). Never use bleach!
- To apply the solution, it is advisable to use a soft cloth. In the case of stainless steel dispensers, especially if satin, it is also possible to use a medium abrasive cloth (for example 3M's Scotch-Brite). Once the application is complete, rinse thoroughly with water and dry the surface with a soft absorbent cloth.

STATUS	CLEANING AGENT	APPLICATION METHOD
Dirt, soap smudges and fingerprints	Use a mild cleanser or specific detergent for the material to be treated;	Apply the cleaner. Clean the dirt with a cloth or a sponge for smooth surfaces and a soft surface brush structured. Rinse and dry.
Stubborn stains;	Specific detergent, liquid or spray for the material to be treated;	Follow the instructions given on the detergent packaging. Rinse or dry
Rust resulting from exposure to chemicals and / or environmental difficult conditions;	Bathroom cleaners containing phosphoric acid + 3M cloth Scotch Brite or equivalent	Clean the surface as indicated above, then lightly rub the area with the cloth. Clean with a suitable polish for the treated surface. Then, rinse and dry.

FOR PRODUCT CARE

PRECAUTIONS FOR STAINLESS STEEL DISPENSERS:

Although stainless steel is very resistant to oxidation and rust, there are some conditions in which it can be found due to the factors listed below:

- Detergents for acid chloride or muriatic acid (hydrochloric acid);
- Concentrated soap residue where chemical additives can cause discoloration and can potentially dry out and thus appear rusty;
- Environments where water has a high iron content or where there is contact with it (e.g. steel wool, processing shavings, iron residues or dust in the installation or when cleaning other products in steel) may leave a residue of rust. The presence of salt containing chlorides.

Remove rust or corrosion as soon as possible to avoid permanent surface discoloration and pitting.

RECOMMENDATIONS:

- Never clean stainless steel dispensers with cleaners containing bleach, chlorides, hydrochloric acid and muriatic acid. These are often found in toilet bowls or in abrasive tiles and powders.
- Never use abrasive cleaners on a shiny stainless steel surface.
- Never use steel wool, as it would scratch the finishes.
- Never use metal sponges or any other sponge that may leave rust particles on the surface.
- In brushed dispensers, clean or wipe in the direction of the satin finish.
- Do not wash them under running water, do not immerse them in water.
- Never scrape with steel tools.

FILL THE DISPENSER:

Make sure you fill the dispenser with the right type of soap, liquid, foam or disinfectant by the hands. The use of other types of liquids is not covered by our warranty. After filling, be sure to clean the liquid from the container.

KEEP THE INNER UNIT CLEAN:

Most soap dispenser problems are caused by the type of consumable used. Very thick or very concentrated soaps risk causing blockages in the delivery system, so they must be diluted with water. Excessively liquid or too diluted soaps reduce the viscosity of the soap itself with the consequent of the same from. A problem commonly encountered with soap dispensers is the use of detergents that are too basic or too acidic. Our dispensers are designed to be used with neutral PH soaps. Acid soaps (PH levels below 6.5) corrode metal parts and degrade plastic components. Basic soaps (PH levels above 8.5) also cause swelling or damage to rubber and plastic parts, as well as skin irritation.

If you use good soap, internal valve problems can be caused by a lack of maintenance. If the appliance is not used for a long period of time or if the nozzle becomes clogged, the following instructions should be followed: clean the dispenser internally at regular intervals of one week by pouring only hot water into a tank and pump gently to clean the block and remove the soap residue. In case of extreme obstruction, therefore for special cleaning, the tank must be disassembled and pumped to restore correct operation: remove both reservoirs and the pump from the dispenser or remove the dispenser from the wall if possible. (This is possible with models in which the tank is mounted in the unit); drain all soap from the tank, then immerse the tank and pump in hot water for 30 minutes. This will help remove any clean or thick soap residue. Pump the valve at least 20 times to remove any blockages while it is still wet. Once cleaned, rub the components with a cloth and reassemble them together or back up to the wall brackets, remembering to fasten the unit to the brackets and screws.

ATTENTION:

Never try to insert a pointed object (eg a pin) into the soap spout, as it could cause irreparable damage to the pump and void the warranty.

A JOURNEY OF FORTY YEARS

EXPLORE WITH US!

THANKS TO OUR:

EXPERIENCE AND RELIABILITY

We've been successfully completing projects for years, guaranteeing precision and care in every detail.

QUALITY THAT MAKES A DIFFERENCE

The highest quality materials, techniques and workmanship for excellent results.





CREATIVITY AND INNOVATION

We design solutions that combine creative vision, strategic thinking and functionality.

CUSTOMISATION

Each project is unique, and it is built around the customer's needs to enhance the product with the required brand strategy.

360-DEGREES ATTENTION

From idea to completion, we have a dedicated team, always at your side.





SALES DEPARTMENT - ITALY

info@medialinternational.com

Tel. +39 02 90660436 (int. 1 e int. 2)

EXPORT DEPARTMENT

export@medialinternational.com

Tel. +39 (0)2 90661110

CUSTOMER SERVICE - ITALY

info@medialinternational.com

Tel. +39 (0)2 90660436 (int. 3)

CUSTOMER SERVICE - EXPORT

export@medialinternational.com

Tel. +39 (0)2 90661110

ACCOUNTS DEPARTMENT

amministrazione@medialinternational.com

Tel. +39 02 90660436 (int. 4)

MARKETING DEPARTMENT

marketing@medialinternational.com

Tel. +39 (0)2 90661110



Medial International S.p.A.

C.F. e P.IVA 07834000155

Via Volta, 7/9 - 26837 Mulazzano (Lodi) - Italy

Tel. +39 02 90660436 - Fax +39 02 90661441

www.medialinternational.com

2025



Tel. +39 02 90660436 | Fax +39 02 90661441
export@medialinternational.com | www.medialinternational.com



Company certified under ISO 9001 Quality Management System

Retailer